

No. : OM-E3291-0C

# FURUNO

# OPERATOR'S MANUAL

MARINE RADAR

MODEL FR-810DS

(Incl. Installation Instructions)



**FURUNO ELECTRIC CO., LTD.**  
NISHINOMIYA, JAPAN

861010T (860)  
PRINTED IN JAPAN

**C O N T E N T S**  
 \* \* \* \* \*

	<u>Page</u>
SPECIFICATIONS	0-1 to 0-7
CHAPTER 1 OPERATION INSTRUCTIONS	1-1 to 1-18
1.1 Function of Each Control	1-1
1.2 Operating Procedure	1-10
1.3 Range Measurement	1-12
1.4 Bearing Measurement	1-13
1.5 Radar Alarm Setting	1-14
1.6 Detection of Birds	1-15
1.7 Effect of Sea & Rain/Snow Clutter Reduction	1-17
CHAPTER 2 REMARKS ON VIEWING PICTURE	2-1 to 2-5
2.1 Minimum and Maximum Ranges	2-1
2.2 Radar Resolution	2-1
2.3 Bearing Accuracy	2-2
2.4 Range Measurement	2-2
2.5 False Echoes	2-2
CHAPTER 3 MAINTENANCE	3-1 to 3-3
CHAPTER 4 TROUBLESHOOTING	4-1 to 4-12
4.1 Self-check for Memory Device	4-1
4.2 Trouble Finding List	4-3
SCHEMATIC DIAGRAMS	S-0 to S-11

APPENDIX 1 INSTALLATION INSTRUCTIONS	AP1-1 to AP1-28
1.1 General	AP1-1
1.2 Siting of the Units	AP1-1
1.3 Scanner Unit Installation	AP1-2
1.4 Display Unit Installation	AP1-8
1.5 Rectifier Unit Installation	AP1-12
1.6 Connections	AP1-14
1.7 Preoperation Checks and Adjustment	AP1-22
APPENDIX 2 SETTING OF INTERNAL DIP SWITCH	AP2-1 & AP2-2

SPECIFICATIONS OF FR-810DS RADAR  
 \* \* \* \* \*

SCANNER UNIT

- 1. Radiator: Slotted Waveguide Array
- 2. Radiator Length: 250cm (SN-4A)
- 3. Horizontal Beamwidth: 2.6°
- 4. Vertical Beamwidth: 25°
- 5. Polarization: Horizontal
- 6. Antenna Rotation: Approx. 24 r.p.m. nominal (without wind load)
- 7. Wind Load: Relative wind 51.5 m/s (100 knots)

TX MODULE & RECEIVER CIRCUIT (Contained in the scanner housing)

- 1. Transmitting Tube: Magnetron MG5315
- 2. Frequency & Modulation: 3050MHz ± 30MHz (S-band), PON
- 3. Peak Output Power: 10kW nominal
- 4. Pulselength & Pulse Repetition Rate:

Pulselength	Pulse Repetition Rate(Hz)	Range									
		0.25	0.5	0.75	1.5	3	6	12	24	48	72
Short (S) 0.08us	Approx. 3000	S									
Middle 1 (M1) 0.3us	Approx. 2200					M1					
Middle 2 (M2) 0.6us	Approx. 1200							M2			
Long (L) 1.2us	Approx. 600 (*1)	L									

(\*1): Approx. 490Hz on 72 n.m. range

- 5. Modulator: SCR line type pulse modulator
- 6. IF Amplifier: I.F. ----- 60MHz  
Bandwidth ----- 28MHz/3MHz  
Characteristic --- Logarithmic
- 7. Tuning: Manual, with tuning marker
- 8. Receiver Front End: MIC (Microwave IC)
- 9. Duplexer: Circulator and diode limiter

DISPLAY UNIT

- 1. Indication System: PPI, Daylight Display
- 2. Picture Tube: 12 inch rectangular CRT
- 3. Range:
- 4. Range Ring Interval:
- 5. Number of Rings:

0.25	0.5	0.75	1.5	3	6	12	24	48	72	n.m.
0.05*	0.1*	0.25	0.25	0.5	1	2	4	8	12	n.m.
5	5	3	6	6	6	6	6	6	6	

\* Ring intervals of 0.1 and 0.2km available for 0.25 and 0.5 n.m. ranges respectively with preset switch inside.

- 6. Display Mode:
  - 1) Head-up
  - \*2) North-up
  - \*3) Course-up
  - \*: Only when a gyro interface (option) is connected.
- 7. Bearing Resolution: Within 3.0°
- 8. Bearing Accuracy: Better than 1°
- 9. Range Discrimination: Better than 31m
- 10. Minimum Range: Better than 36m
- 11. Range Ring Accuracy: 0.2%
- 12. VRM Accuracy: 0.2%
- 13. Mark Indication: Heading Mark, North Mark, Bearing Scale, Range Ring, No.1/No.2 VRMs, No.1/No.2 EBLs, Tuning Mark and Alarm Zone Mark
- 14. Numeral/Character Indication: Range, Range Ring Interval, Display Mode (HU,CU,NU), Pulselength (S,M1,M2,L), Plot Interval, Interference Rejection (IR), Radar Alarm (ALM), Ship's Bearing, EBL Bearings (No.1/No.2 EBLs), VRM Ranges (No.1/No.2 VRMs) and Echo Stretch (ES), Bearing Mode (R for relative, T for true)
- 15. Plotting Mode: Continuous plotting or plotting at selected interval; 15sec, 30sec, 1min, 3min and 6min
- 16. Interference Rejector: Built in
- 17. Radar Alarm: Built in

ENVIRONMENT CONDITION

1. Vibration:

Total Amplitude	Vibration Cycle
+ 1.6 mm	1 to 12.5Hz
+ 0.38 mm	12.5 to 25Hz
+ 0.10 mm	25 to 50Hz

2. Ambient Temperature:

Scanner Unit ----- -25°C to +70°C  
 Display Unit ----- -15°C to +55°C

3. Humidity:

Relative humidity, 95% at +40°C

POWER SUPPLY & POWER CONSUMPTION

24VDC (20.4 to 31.2VDC) directly, 150W or  
 100/110/115/220/240VAC, 1ϕ, 50/60Hz with rectifier (RU-1746B-2, option)

COATING COLOR

1. Display Unit ----- Munsell 2.5GY5/1.5 Embossed T25 (Light gray) for Cabinet,  
 Munsell N3.0 Newtone No.5 (Dark gray) for Control Panel
2. Scanner Unit ----- Munsell N9.5
3. Rectifier Unit ---- Munsell 2.5GY5/1.5 Newtone No.5 (Light gray)

COMPLETE SET

No.	Name	Type	Q'ty	Weight	Remarks
1	Scanner Unit	RSB-0019-SN4A	1	75 kg	
2	Display Unit	RDP-038T	1	20 kg	Tabletop mount
		RDP-038B			Bulkhead mount
3	Rectifier Unit	RU-1746B-2	1	17 kg	AC mains only
4	Accessories	FP03-00100	1 set		
5	Installation Materials		1 set		
6	Standard Spare Parts	SP03-02400	1 set		

OPTIONAL SUPPLY

No.	Name	Type	Code No.	Remarks
1	Power Cable	CVVS-8x2C	000-560-634	15m
2	Filter Assembly	OP03-1	008-290-100	
3	Outer Alarm Buzzer	OP03-21	000-030-097	
4	Radar Color Display	CD-140		
5	Radar Color Display	CD-141		
6	Gyro Interface	AD-10S		
7	Performance Monitor	PM-5		
8	De-icer	OP03-24	008-206-060	
9	Transformer	RU-3305		For de-icer
10	Radar Slave Display	FMD-800		

ACCESSORIES (Type: FP03-00100, Code No.: 000-081-105)

No.	Name	Type	Code No.	Q'ty	Remarks
1	Vinyl Cover	03-011-0401-0	000-879-490	1	For display unit
2	Hood Assembly	FP03-00110	008-111-640	1	For display unit

STANDARD SPARE PARTS (Type: SP03-02400, Code No.: 000-081-035)

No.	Name	Type	Code No.	Q'ty	Remarks
1	Pilot Lamp	T3.8 8V, 60mA	000-540-180	2	
2	Fuse	FGBO 10A AC125V	000-549-065	4	For ship's mains & scanner motor
3	Fuse	FGRO 0.5A AC125V	000-549-060	2	For TX HV
4	Fuse	UL-TSC, 125V2A	000-101-132	3	For CRT display
5	Label (1)	03-011-1051-0	301-110-510	1	For tabletop mount (English)
6	Label (2)	03-011-1052-0	301-110-520	1	For bulkhead mount (English)
7	Label (18)	03-011-1068-0	100-043-630	1	For tabletop mount (Japanese)
8	Label (19)	03-011-1069-0	100-043-640	1	For bulkhead mount (Japanese)
9	Carbon Brush	S00152-1B-10 5 x 6 x 11	000-107-120	4	For scanner motor
10	Hex. Wrench	Diagonal: 1.5mm	000-830-112	1	
11	Spare Parts Box	F710 type	000-831-610	1	

INSTALLATION MATERIALS

For Display Unit

("No.1 to No.6": Type: CP03-02502, Code No.: 008-206-900)

No.	Name	Type	Code No.	Q'ty	Remarks
1	NH Connector Assembly	03-302 (4P)	008-300-570	1	For gyro interface
2	Crimp-on Lug	8NK4	000-538-180	4	For power cable
3	Crimp-on Lug	FV5.5-4	000-538-123	3	For rectifier
4	Hex. Nut	M3	000-863-204	2	For DP-1
5	Flat Washer	M3	000-864-104	2	
6	Spring Washer	M3	000-864-204	2	
7	Signal Cable Assembly (Multicore cable)	S03-8-15 (RW-4873 *15M*) S03-8-20 (RW-4873 *20M*) S03-8-30 (RW-4873 *30M*)	008-205-940 008-205-950 008-205-960	1	To be selected (With connectors at display end)

For Scanner Unit

(Type: CP03-02501, Code No.: 008-206-860)

No.	Name	Type	Code No.	Q'ty	Remarks
1	Hex. Bolt	M12x60 SUS304	000-862-191	4	For mounting scanner unit
2	Hex. Nut	M12 SUS304	000-863-112	4	
3	Flat Washer	M12 SUS304	000-864-132	4	
4	Spring Washer	M12 SUS304	000-864-263	4	
5	Seal Washer	03-001-3002-0	300-130-020	4	
6	Corrosion-proof Rubber Mat	03-017-0301-1	100-050-931	2	

Continued

No.	Name	Type	Code No.	Q'ty	Remarks
7	Crimp-on Lug	FV5.5-4	000-538-123	8	
8	Crimp-on Lug	FV1.25-3	000-538-113	29	
9	Crimp-on Lug	320882	000-537-110	1	For coaxial cable
10	Grounding Wire	RW-4747 (IV-8, *0.32M*)	000-566-000	1	For grounding scanner unit
11	Hex. Bolt	M6x25 SUS304	000-862-180	1	
12	Hex. Nut	M6 SUS304	000-863-109	1	
13	Flat Washer	M6 SUS304	000-864-129	3	
14	Spring Washer	M6 SUS304	000-864-260	1	

For Antenna Assembling (Supplied with antenna radiator)

No.	Name	Type	Code No.	Q'ty	Remarks
1	Hex. Bolt (B) (Slotted, washerhead)	M6x16 SUS304	000-882-061	8	
2	Flat Washer	M10 SUS304	000-864-131	8	
3	Spring Washer	M10 SUS304	000-864-261	8	
4	Hex. Bolt	M10x20 SUS304	000-862-158	8	
5	O-ring	WP-20 1115-70	000-851-714	2	
6	Adhesive (Silicone sealant)	1211 50g	000-854-118	1	

CHAPTER 1 OPERATION INSTRUCTIONS

Adjustment and function for the respective operating controls is discussed in this chapter. The operating personnel should familiarize himself with all the operating controls in order to make the best possible use of the equipment.

1.1 Function of Each Control (See page 1-18.)

POWER Switch

This switch turns on/off the power supplied to the radar system. Turn it to ON (OFF) to initiate (or cease) the radar operation.

Shortly after the unit is turned on, the 3 minute timer and internal dip switch setting (See page AP2-1.) will appear on the screen as shown in Fig.1-1. The timer will count down from "3:00" to "0:00", and the display will change to the "ST-BY" indication, showing that the radar is ready to transmit. When the TX touchpad is depressed before the "ST-BY" indication appears, i.e., while the time counts down, the "TX" indication appears below the timer indication and then radar will be put in transmission condition automatically at the moment the timer indicates "0:00."

NOTE: The self-check for memory devices (ROM/RAM) is carried out automatically at every power-up. Confirm that the ROM1, ROM2 and RAM are indicated by "OK" at the bottom of the display. See Fig.1-1. If the self-check sequence detects a failure of some block, the message "ERROR" is displayed such as "ROM1 ERROR". Refer to Section 4.1 Self-check for Memory Device on page 4-1 for more details.

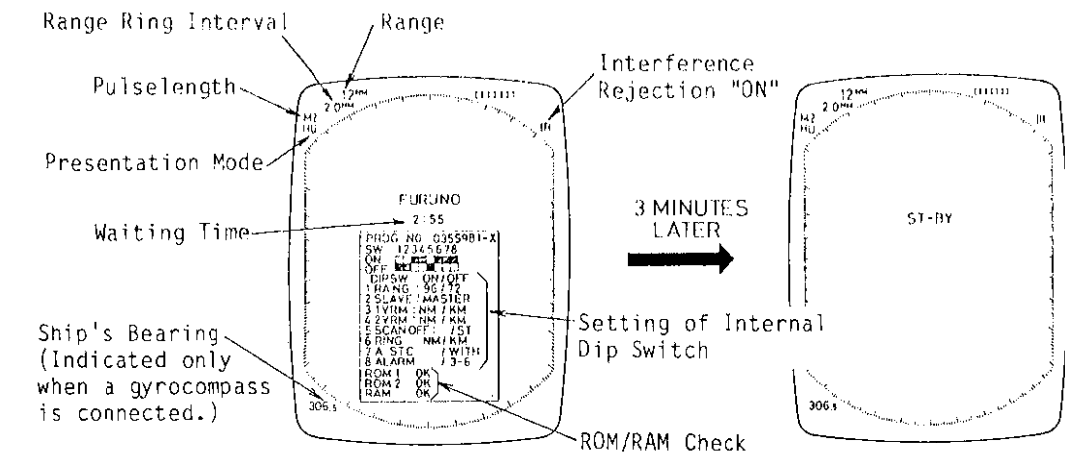

Fig.1-1

Fig.1-2

SCANNER Switch

When this switch is turned to ON with the **POWER** switch turned on, the antenna begins to rotate. Confirm that there is no obstruction around the antenna before turning on this switch.

When this switch is turned to OFF, the radar is put in standby condition irrespective of TX touchpad setting.

TX (Transmit/Pulselength) Touchpad



Press this touchpad while the indication of the "ST-BY" is displayed on the screen as shown in Fig.1-2, and the radar pulses are transmitted and then any echoes reflected from the targets are received and displayed on the screen. - TRANSMIT Condition.

The pulselength and pulse repetition rate are determined by the combination of the settings of this touchpad and RANGE switch as shown in Table 1-1. Pressing this touchpad during the transmission changes the pulselength and pulse repetition rate in the middle ranges (1.5 n.m. to 24 n.m.). When the radar is changed from TX to ST-BY, then to TX again in the middle ranges, the pulselength being selected under the previous TX condition is indicated on the screen.

NOTE: By changing the internal dip switch setting, the shorter pulselength can be always selected for the regulation in some countries when the radar is changed as above (TX→ST-BY→TX) in the middle ranges. See page AP2-1.

Select the short pulse for better picture definition and the long pulse for detection of echoes. The pulselength is indicated as "S" (0.08us), "M1" (0.3us), "M2" (0.6us) and "L" (1.2us) at the top left of the screen. See Fig.1-3.

Table 1-1

Pulselength	Pulse Repetition Rate(Hz)	Range													
		0.25	0.5	0.75	1.5	3	6	12	24	48	72				
Short (S) 0.08us	Approx. 3000			S											
Middle 1 (M1) 0.3us	Approx. 2200				M1										
Middle 2 (M2) 0.6us	Approx. 1200						M2								
Long (L) 1.2us	Approx. 600 (*1)								L						

(\*1): Approx. 490Hz on 72 n.m. range

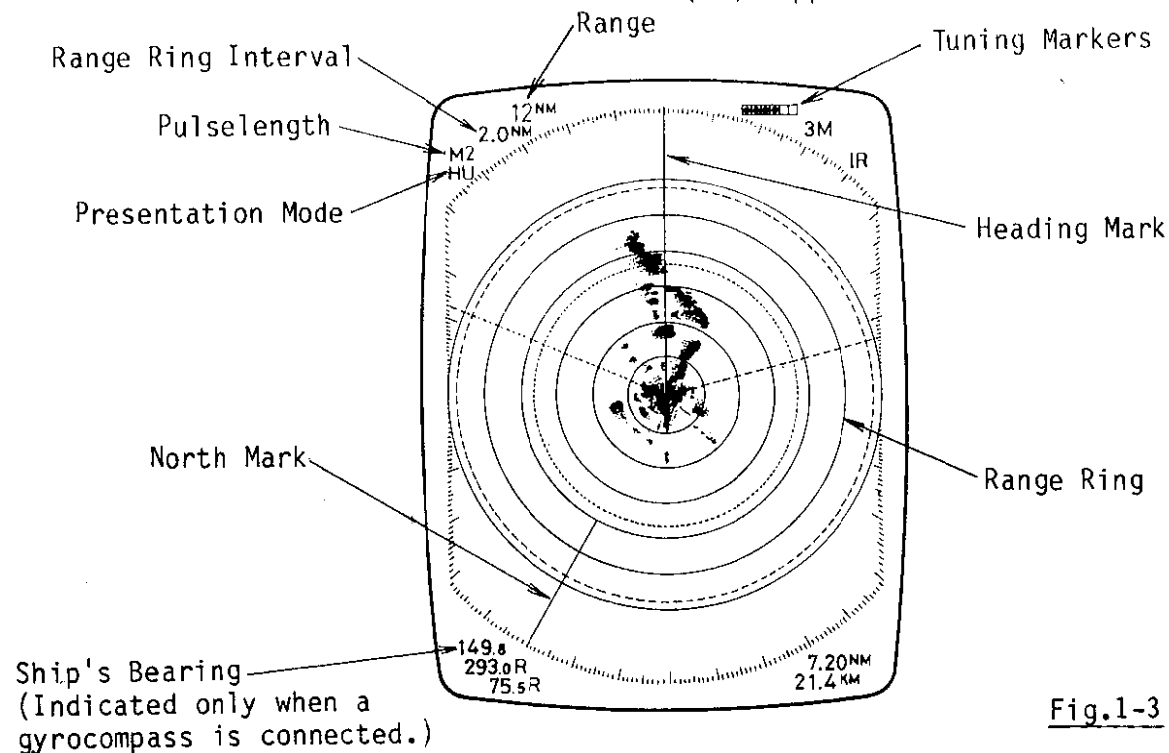

Fig.1-3

ST-BY Touchpad



Pressing this touchpad stops the transmission. Press the TX touchpad again to present the radar picture on the screen. This touchpad is utilized when the use of the radar is temporarily suspended.

RANGE Switch

This 10 position range switch selects the detection range. See Table 1-2. The range selected determines automatically the range ring interval. The pulselength and the pulse repetition rate are also determined by the combination of this switch and the TX touchpad.

Table 1-2 Range and Range Ring Interval

Range	0.25	0.5	0.75	1.5	3	6	12	24	48	72	n.m.
Range Ring Interval	0.05	0.1	0.25	0.25	0.5	1	2	4	8	12	
Number of Rings	5	5	3	6	6	6	6	6	6	6	pcs.

PANEL DIMMER Control

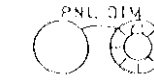

This adjusts the illumination of the control panel. Turning it CW increases the brightness of the illumination.

BRILLIANCE Control



This adjusts the brightness of the picture. Turning it CW increases the intensity of the radar echo blips.

MARK BRIL Touchpad



This touchpad changes the brightness of the characters, numerals and marks (range rings, EVRM and EBL) presented on the screen in 4 steps. Every depression of touchpad changes the brightness stepwise.

ECHO STRETCH Touchpad



This magnifies small blips in middle and long pulselength settings ("M1"/"M2"/"L") for better distinction of echoes. The "ES" is indicated at the top right of the screen when this touchpad is turned on. If this is pressed in short pulselength setting ("S"), the indication of the "ES" is presented in black with green background to inform the operator that ECHO STRETCH mode is inactive.

**TUNE Control** 

This control is used to tune the receiver in the transmitter. Set the RANGE switch at the maximum range and the STC (anti-clutter sea) control at minimum, then finely adjust this control so that the maximum number (normally 4 or 5 pcs.) of the tuning markers, located at the top right of the screen, are lit. The best tuning is normally obtained at mid-travel.

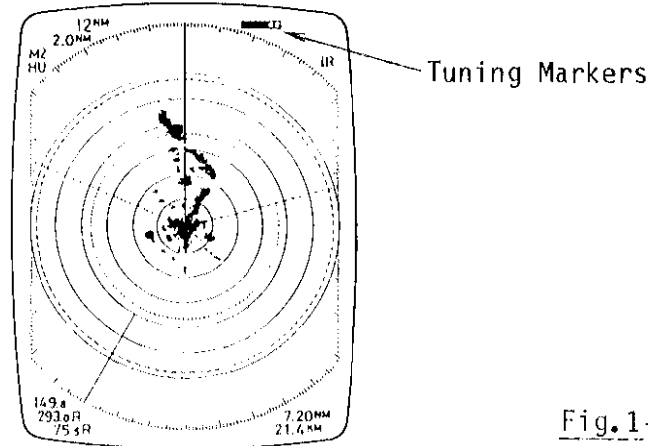

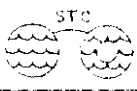

Fig.1-4

**GAIN Control** 

This control adjusts the sensitivity of the receiver amplifier. Turning it CW increases the receiver gain. Normal setting for this control around 60% of its travel produces slight background speckles (white noise) on the screen. On short ranges, it is recommended that the GAIN control is set almost fully CW and the STC control for best picture presentation.

**STC (anti-clutter sea) Control** 

This control reduces the gain at close range to reduce sea clutter caused by multiple random echoes from waves. Since this control is effective over the screen on short ranges, it is recommended to use this control in place of the GAIN control to adjust gain in short ranges. In this case, combined use of the FTC and STC controls is effective to obtain a quality picture, reducing sea clutter.

**FTC Control** 

The solid clutter caused by heavy precipitation is gradually reduced by turning this control CW, and the definition of picture is improved.

This control can also be used advantageously to separate groups of echoes on a congested short range picture, and further this is useful to diminish the sea clutter, using the GAIN control as well as the STC control. Too high a setting of the FTC control makes the target echo small in size or causes it to disappear.

**IR (Interference Rejection on/off) Touchpad** 

When radar interference from other radars operating in the vicinity is observed on the screen, press this touchpad to eliminate it. The indication of the "IR" appears at the top right of the screen when the interference rejector circuit is activated. See Fig.1-5.

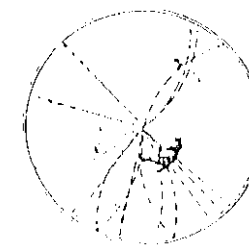

Interference Rejector OFF

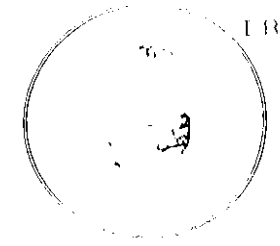

Interference Rejector ON

Fig.1-5

**RING (Range Ring on/off) Touchpad** 

This touchpad turns on/off the fixed range rings. The number and interval of rings vary depending on the range setting as shown in Table 1-2. The range ring interval is indicated at the top left of the screen as shown in Fig.1-3.

Only for 0.25 n.m. and 0.5 n.m. ranges, the range ring interval can be indicated in kilometers instead of n. miles by changing the internal dip switch setting. See page AP2-1.

**HM OFF (Heading Mark off) Touchpad** 

The heading mark disappears while this touchpad is depressed. Should a small desired target be under the heading mark, use this touchpad.

**NM (North Mark on/off) Touchpad** 

The North Mark, which is available when a gyrocompass is connected, is turned on or off by this touchpad. The ship's bearing is always indicated at the bottom left of the screen as long as a gyrocompass is connected. See Fig.1-3.



**MODE Touchpad**



The following three modes ("HU"/"CU"/"NU") can be selected in order by pressing this touchpad successively. When a gyrocompass is not connected, neither "CU" nor "NU" mode is available (Only "HU" mode is available). One of "HU", "CU" and "NU" is indicated at the top left of the screen corresponding to the mode setting as shown in Fig.1-3.

**"HU" (Head-up)**

The picture is orientated so that the heading mark appears at the top of the screen. This mode is most suitable for navigation on congested water areas or narrow channels.

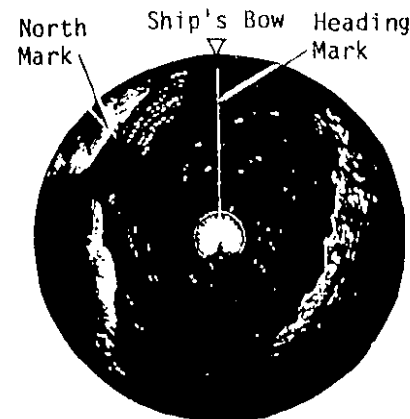

Fig.1-6 Head-up Mode

**"CU" (Course-up)**

Press the **MODE** touchpad for "CU" mode at the moment the ship's bow is faced in the desired direction (ship's course to port, waypoints, etc.), and the picture is stabilized so that the desired direction is at the top of the screen. The heading mark wanders according to the orientation of ship's heading. The picture is stabilized against yaw of the vessel.

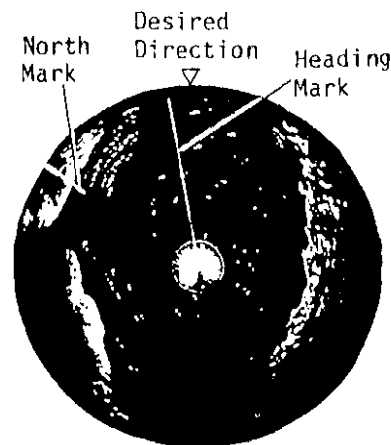

Fig.1-7 Course-up Mode

**"NU" (North-up)**

The radar picture is stabilized so that North is at the top of the screen and the heading mark wanders according to the orientation of ship's heading. Therefore, this mode is available for measurement of ship's position and as a navigation monitor on the navigational chart. The picture is stabilized against yaw of the vessel, reducing shift of target echoes.

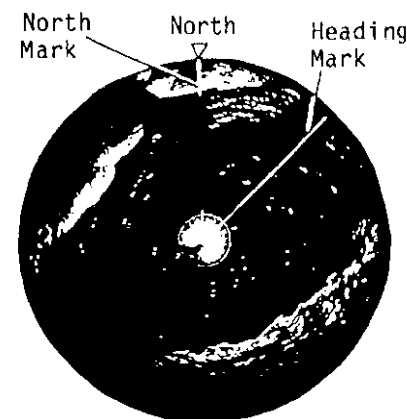

Fig.1-8 North-up Mode

**PLOT (Picture Memory) Touchpad**



This is to present the movement of other ships relative to your own ship on the screen. Press this touchpad, and continuous plotting of moving targets takes place and the time elapsed after starting the plot operation is indicated at the top right of the screen, counting up to 99 minutes and 59 seconds. Plot echoes blink every second indicating that the PLOT mode is taking place. If the touchpad is pressed again within 10 seconds, the plot interval of target echoes changes to 15 seconds. Further, pressing it successively within 10 seconds changes the plot interval as follows: 30 seconds, 1 minute, 3 minutes, 6 minutes. If the plot interval is set at 1 minute, the target echoes are memorized repeatedly every minute. The plot interval is indicated at the top right of the screen instead of the continuous plotting time elapsed. To erase the plot picture, press this touchpad 10 seconds after the previous press.

When the **RANGE** switch is turned while the PLOT operation is performed, the plotting time elapsed or the plot interval on the screen is presented in black figure with green background to inform the operator that the PLOT mode is inactive as shown in Fig.1-9. To continue the PLOT operation, turn the **RANGE** switch to its original position.

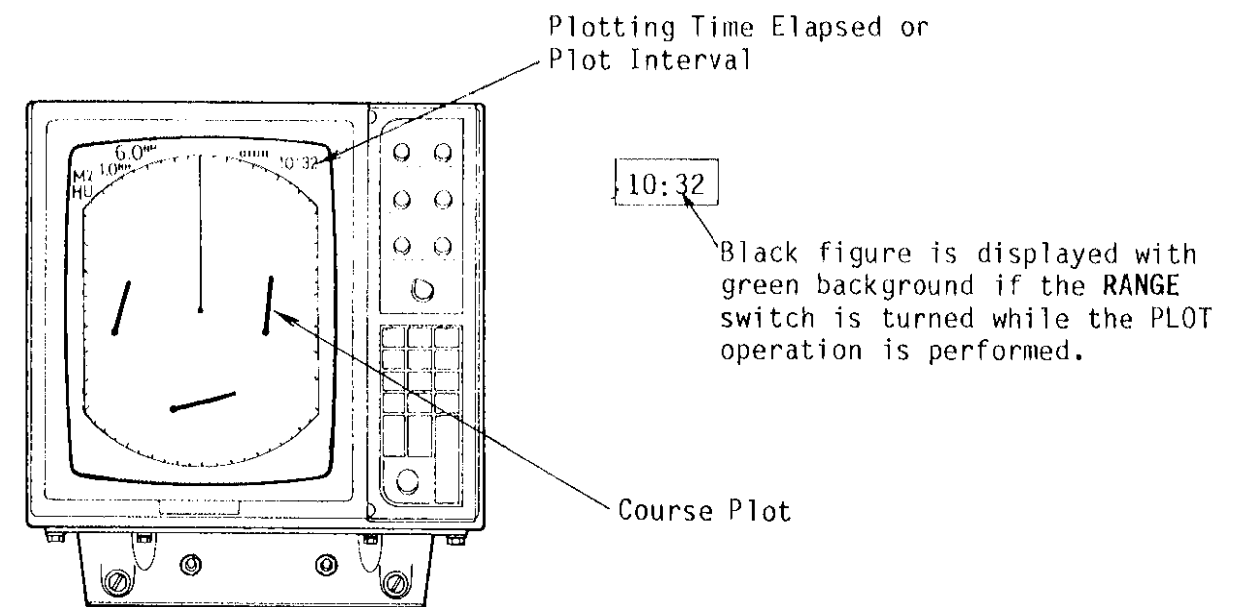



Fig.1-9

**ALARM (Radar Alarm on/off) Touchpad** 

Radar alarm function is turned on and off by pressing this touchpad. When any targets fall into the guard zone selected by VRM and EBL touchpads, the alarm sound is released. Refer to Section 1.5 for the alarm setting. To silence it, press the ALARM pad again. The message "ALM" appears at the top right of the screen to indicate that the alarm function is activated. If the alarm mode is inactive due to improper setting of alarm zone, etc., the indication of the "ALM" is inverted, i.e., it appears in black letters with green background.

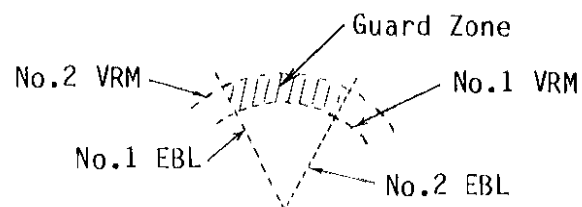
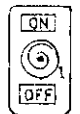

Fig.1-10

NOTE: By changing the internal dip switch setting, the range of the guard zone can be limited between 3 and 6n.m. for the regulation in some countries. See page AP2-1.

**VRM-1 (No.1 VRM on/off) & VRM-2 (No.2 VRM on/off) Touchpads** 

Pressing the "ON" portion (upper half) of each touchpad presents the No.1 or No.2 VRM on the screen as a dotted ring. The distance can be digitally read out at the bottom right of the screen in the unit of nautical miles. (It can be indicated in kilometers by changing the internal setting. See page AP2-1.) To adjust VRM, first press "ON" portion of desired touchpad, VRM-1 or VRM-2, then rotate the No.1/No.2 VRMs & EBLs control.

To distinguish the No.2 VRM from No.1, the length of the dash and space is different as shown in Fig.1-11.

Press the "OFF" portion (lower half) of the touchpad to erase the VRM.

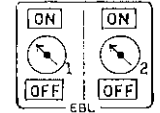
**EBL-1 (No.1 EBL on/off) & EBL-2 (No.2 EBL on/off) Touchpads** 

Pressing the "ON" portion (upper half) of the EBL touchpad presents the EBL on the screen as a dotted line. The bearing of the EBL is displayed at the bottom left of the screen. See Fig.1-11. It is indicated in relative bearing for the "HU" mode ("R" added) and in true bearing for the "NU" mode ("T" displayed instead of "R"). To adjust EBL, first, press the "ON" portion of the touchpad, EBL-1 or EBL-2, then rotate the No.1/No.2 VRMs & EBLs control.

To distinguish between the No.1 and No.2 EBLs, the length of the dash and space is different as shown in Fig.1-11.

Press the "OFF" portion (lower half) of the touchpad to erase the EBL.

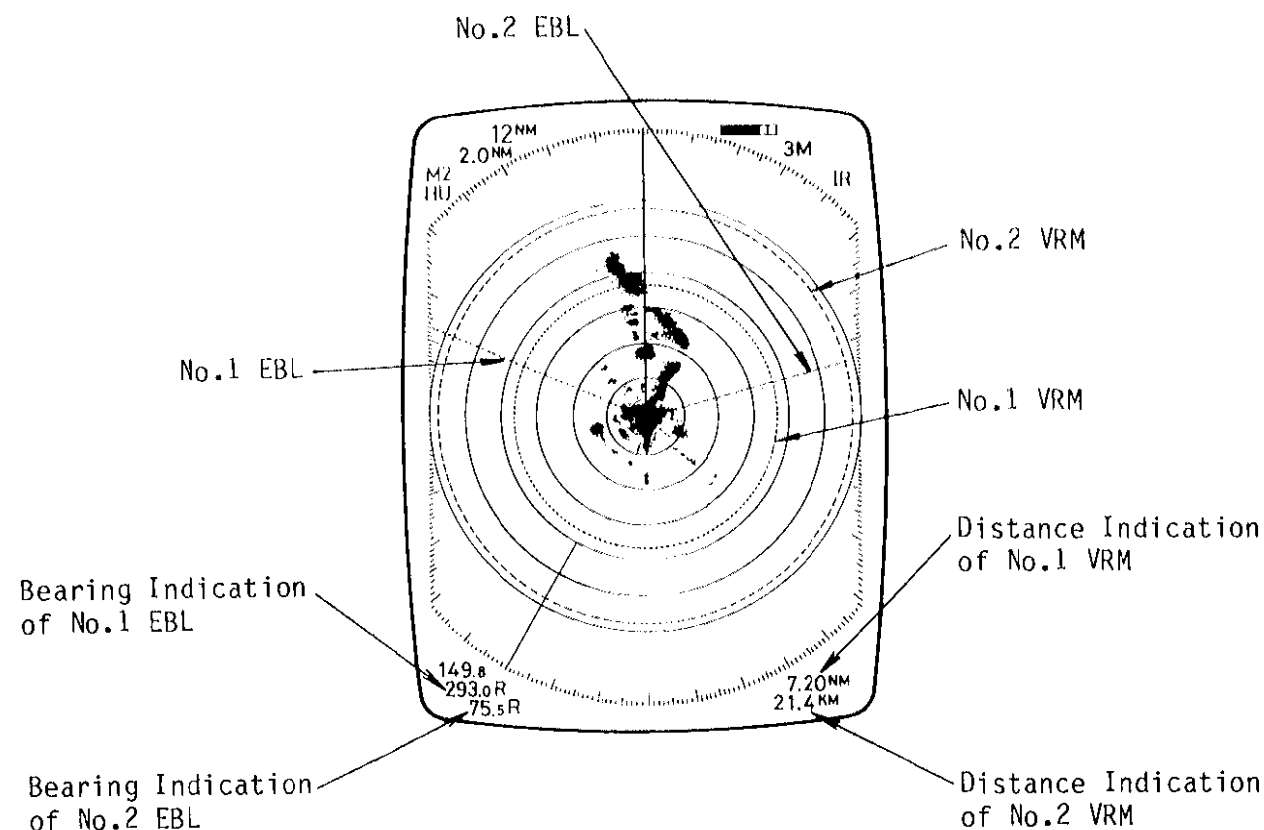

Fig.1-11

**No.1/No.2 VRMs & EBLs Control**

This control is used to adjust VRMs and EBLs. First, press the "ON" portion (upper half) of either one of touchpads, VRM-1, VRM-2, EBL-1 or EBL-2, then rotate this control.

1.2 Operation Procedure

Confirm that the power supply is within the rating, there is no obstruction around the antenna, and the controls and switches on the control panel are set as below before switching on the radar.

Controls & Switches	Settings
POWER & SCANNER	"OFF"
GAIN, STC, FTC, BRILLIANCE	Fully CCW
TUNE	Center
Others	Any positions

Starting

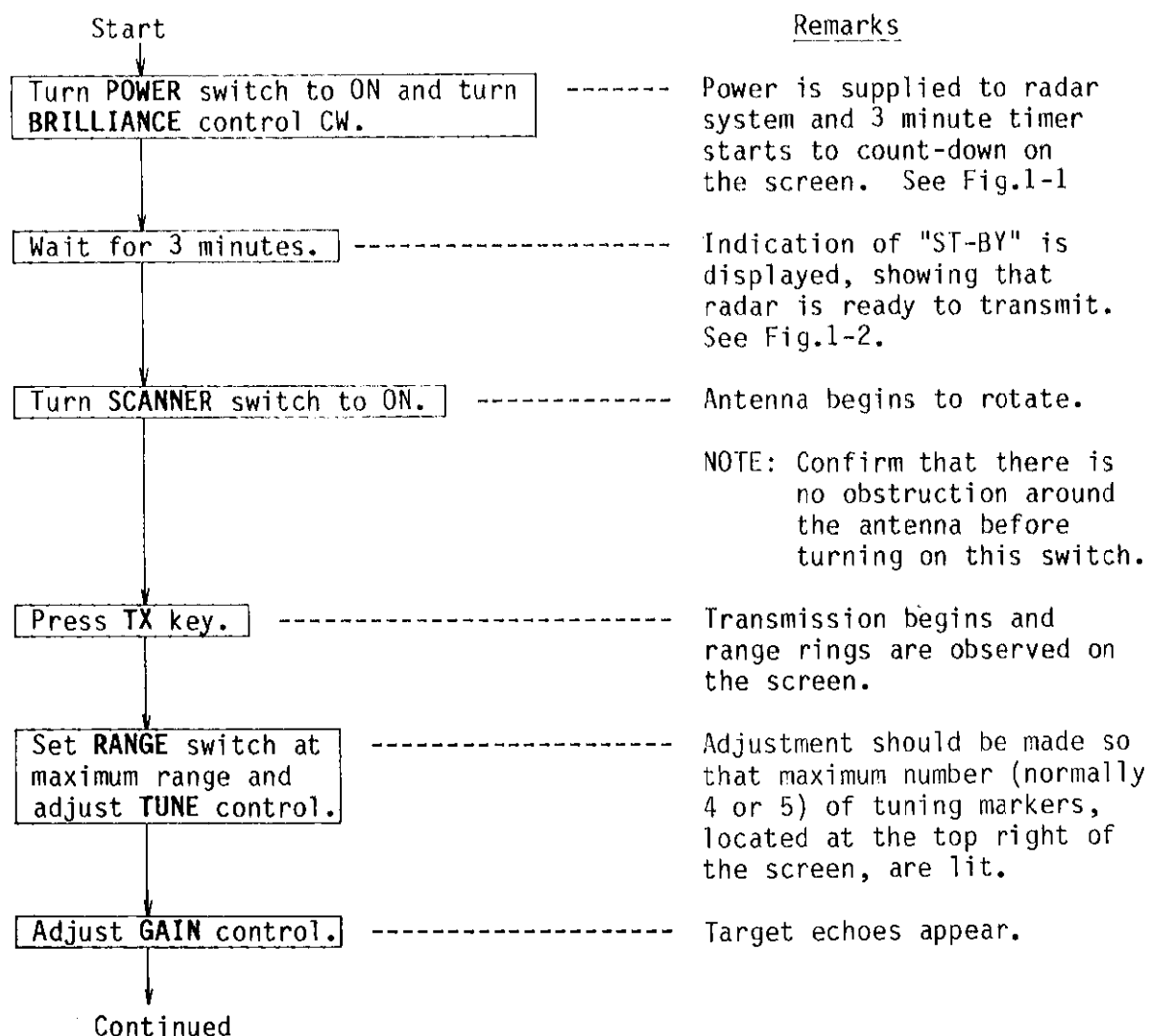

Remarks

- Power is supplied to radar system and 3 minute timer starts to count-down on the screen. See Fig.1-1
- Indication of "ST-BY" is displayed, showing that radar is ready to transmit. See Fig.1-2.
- Antenna begins to rotate.  
NOTE: Confirm that there is no obstruction around the antenna before turning on this switch.
- Transmission begins and range rings are observed on the screen.
- Adjustment should be made so that maximum number (normally 4 or 5) of tuning markers, located at the top right of the screen, are lit.
- Target echoes appear.

Remarks

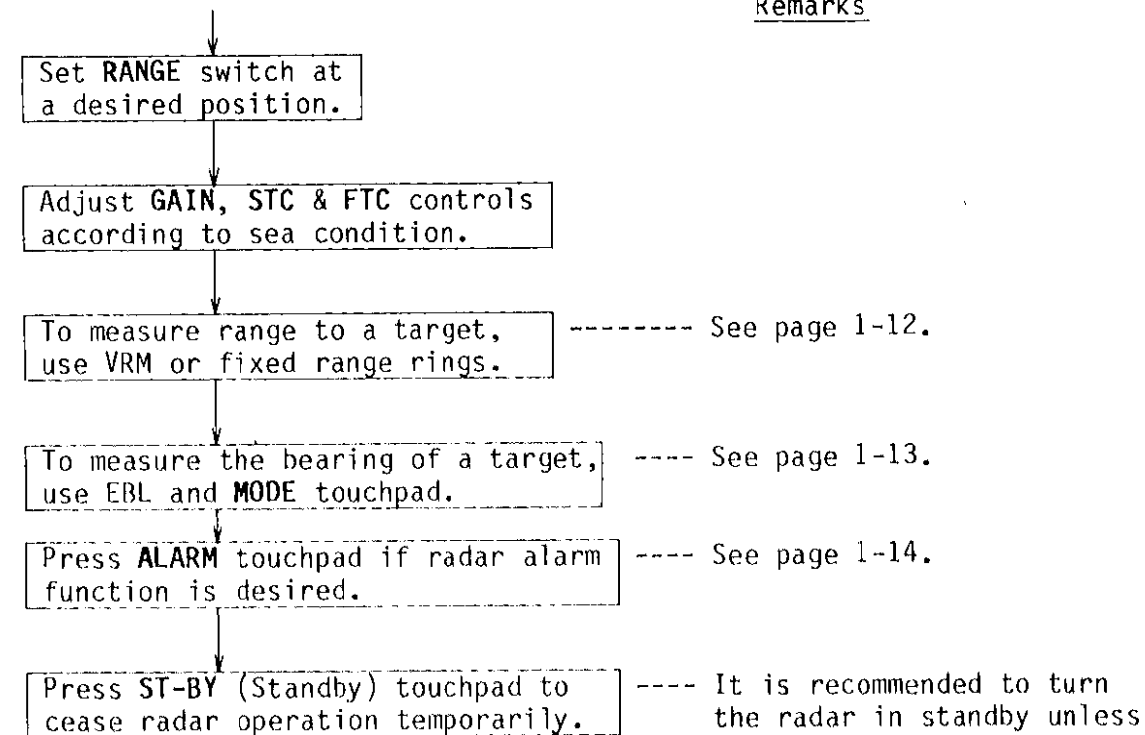

- See page 1-12.
- See page 1-13.
- See page 1-14.
- It is recommended to turn the radar in standby unless observation of picture is necessary for longer life of the magnetron.

Stopping

After turning GAIN & BRILLIANCE controls fully CCW, turn SCANNER switch to OFF and then turn POWER switch to OFF.

1.3 Range Measurement

1. Measurement with fixed range rings

The distance to a target is roughly measured with fixed range rings which are presented by pressing the RING touchpad. The range ring interval is indicated at the top left of the screen.

The ring intervals of 0.1 Km and 0.2 Km are available for 0.25 n.m. and 0.5 n.m. ranges respectively. Refer to page AP2-1.

2. Measurement with variable range marker

For precise measurement of the distance to a target, use the following procedure.

- 1) Press the "ON" portion (upper half) of either of the VRM-1 or VRM-2 touchpad to present the No.1 or No.2 VRM (dotted ring) on the screen.
- 2) Locate the VRM with the No.1/No.2 VRMs & EBLs control at the inner edge of the target.
- 3) The distance to the target is readily indicated at the bottom right of the screen.

Note: The distance can be indicated in nautical miles or kilometers according to the settings of the internal dip switch. Refer to page AP2-1.

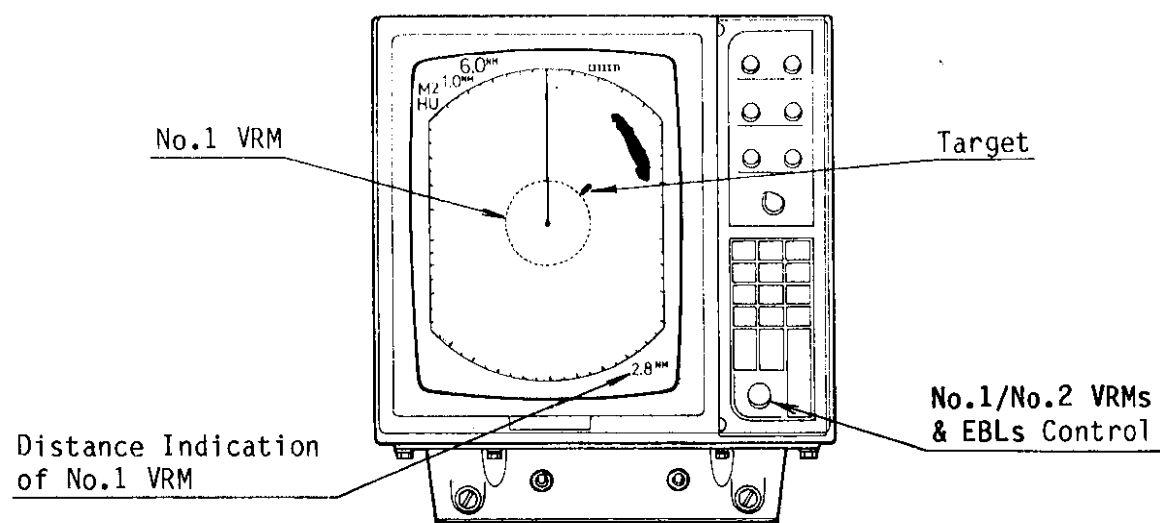

Fig.1-12

1.4 Bearing Measurement

The relative or true bearing to the selected target can be measured as follows.

1. Relative Bearing (See Fig.1-13.)

- 1) Set the presentation mode to "HU" (Head-up) by pressing the MODE touchpad.
- 2) Press the "ON" portion (upper half) of either of the EBL-1 or EBL-2 touchpad to present the EBL on the screen.
- 3) Rotate the No.1/No.2 VRMs & EBLs control until the EBL intersects over the center of the target.
- 4) The bearing of the target is readily indicated at the bottom left of the screen.

2. True Bearing (See Fig.1-14.)

This method is available when a gyrocompass is connected.

- 1) Set the presentation mode to "NU" (North-up) by pressing the MODE touchpad.
- 2) Perform the same procedure as steps 2 thru 4 of "Relative Bearing" mentioned above.

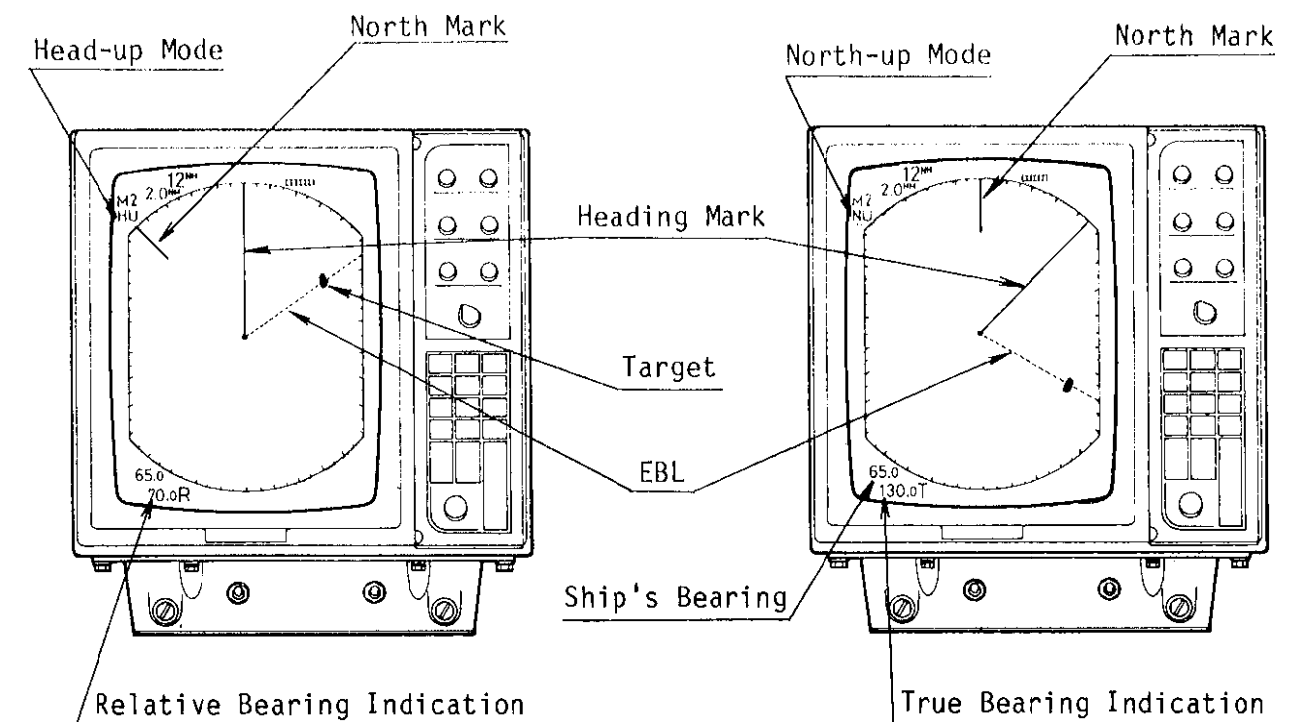

Fig.1-13

Fig.1-14

1.5 Radar Alarm Setting

The guard zone for the alarm can be selected between 0 and 72 n.m. for distance (between 3 and 6 n.m. when preset by the internal dip switch. See page AP2-1.) and between 0 and 360° in bearing. The alarm sound is released when any targets, ships or land mass on the screen fall into the preset guard zone. Use the following procedure to set the guard zone. See Fig.1-10.

- RANGE SETTING -

- 1) Press the "ON" portion (upper half) of the VRM-1 touchpad and rotate the No.1/No.2 VRMs & EBLs control to set the range of the inner edge of the guard zone.
- 2) Press the "ON" portion (upper half) of the VRM-2 touchpad and rotate the No.1/No.2 VRMs & EBLs control to set the range of the outer edge of the guard zone.

- SECTOR SETTING -

- 3) Press the "ON" portion (upper half) of the EBL-1 touchpad and rotate the No.1/No.2 VRMs & EBLs control to set the CCW limit of the alarm sector.
- 4) Press the "ON" portion (upper half) of the EBL-2 touchpad and rotate the No.1/No.2 VRMs & EBLs control to set the CW limit of the alarm sector.

- ALARM SETTING -

- 5) Press the ALARM touchpad, and the letters "ALM" mark will appear at the top right of the screen.
- 6) The alarm sound is released when any targets on the screen fall into the guard zone selected above.

1.6 Detection of Birds (Radar Application to Fishing)

Detection of birds is useful in some types of fishings, especially in tuna/bonito fishings. Since birds usually fly over fish swimming on the sea surface, detection of birds may help you locate fish faster than you can detect them with a sonar or an echo sounder. Birds can be sighted with binoculars out to a distance of approx. 6 to 8 n.m. in good sea conditions. The FR-810DS S-band radar is capable of detecting birds at greater distances, approx. 12 n.m. for a large flock flying about 50m above the sea surface and the antenna mounted 15m above the surface. Birds can be detected by radar even in heavy rain or at night, whereas binoculars can be used only in the daytime and in good weather conditions.

The following shows the recommended settings of controls and switches on the front panel for bird detection and some examples for bird echoes on the radar screen.

<u>Controls &amp; Switches</u>	<u>Settings</u>
GAIN	60% to 70% of its travel (White noise appears.)
RANGE	3 to 12 n.m. range
STC	Fully CCW (minimum)
FTC	"ON" only when raining or snowing
IR	"ON" (Receiver gain must be increased a little.)

NOTE: 1. The TUNE control should be adjusted so that the maximum sea clutter appears on the screen at long range.

Example 1 Condition: GAIN --- 60 to 70% of its travel, STC --- Fully CCW, RANGE --- 6 n.m., IR --- "ON"

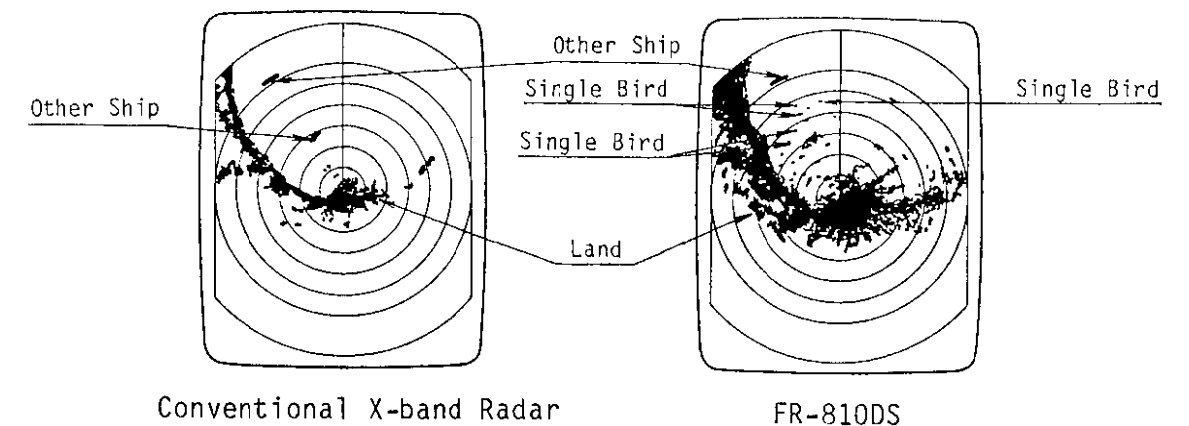

Example 2 Condition: GAIN --- 60 to 70% of its travel, STC --- Fully CCW, FTC --- "OFF", RANGE --- 6 n.m., IR --- "ON" (in a squall)

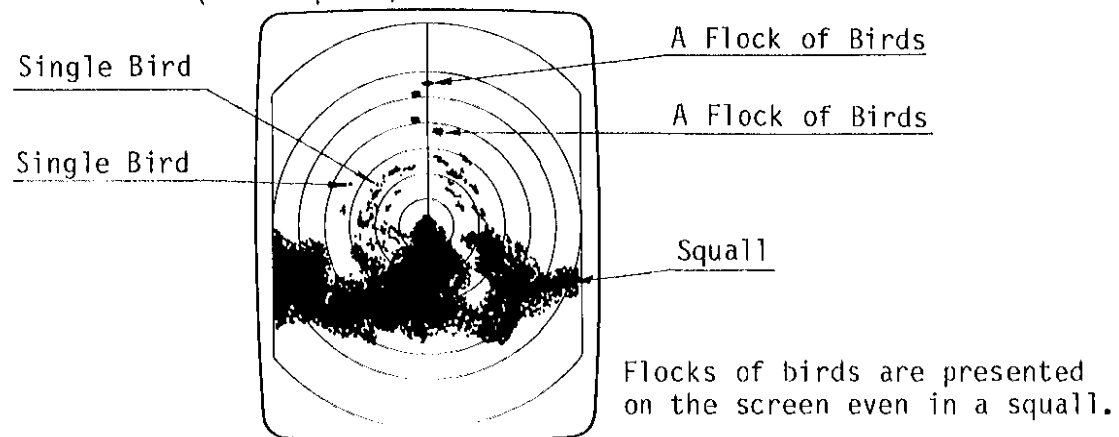

Example 3 Condition: GAIN --- 60 to 70% of its travel, STC --- Fully CCW, FTC --- "ON", RANGE --- 6 n.m., IR --- "ON" (under heavy rain)

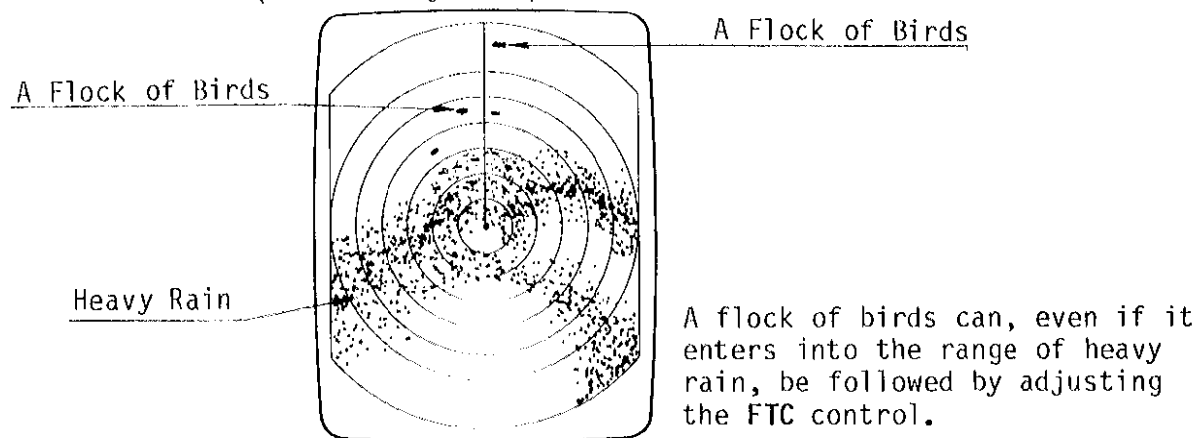

Example 4 Condition: GAIN --- 60 to 70% of its travel, RANGE --- 6 n.m., STC --- 20 to 30% of its travel, IR --- "ON" (in a calm sea)

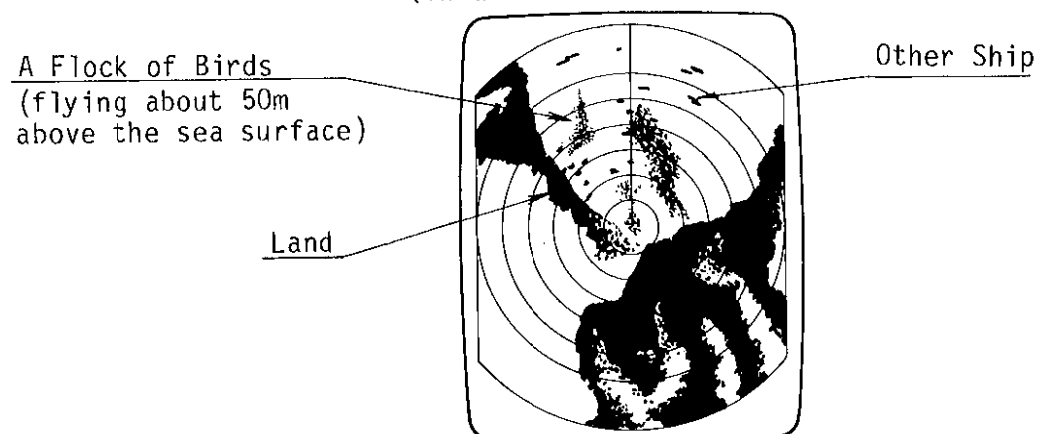

1.7 Effect of Sea & Rain/Snow Clutter Reduction

The FR-810DS S-band radar provides, when compared to conventional X-band radars, better discrimination in areas where the radar is operated in severe weather conditions.

In rough weather, the X-band radar presents sea and solid (rain/snow) clutters on the whole screen, resulting in loss of wanted target echoes. On the contrary, the S-band radar suppresses sea and solid clutters, which are not presented over the screen, and enables (with the FTC control on the front panel turned fully CCW) target echoes in the rain to be discriminated from the clutter. See the figure below. CW turning of the FTC control permits further improvement of discrimination from clutter.

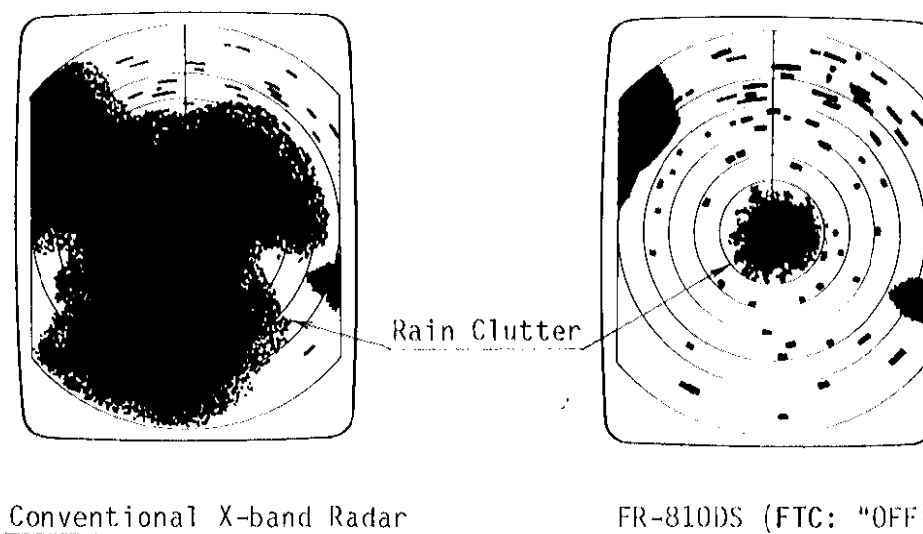

CHAPTER 2 REMARKS ON VIEWING PICTURE

2.1 Minimum and Maximum Ranges

Maximum range

The maximum detecting range of the radar,  $R_{max}$ , varies considerably depending upon several factors such as the height of the antenna above the sea, the height of the target above the sea, the size, shape and material of the target, and the atmospheric conditions.

Under the normal atmospheric condition, the maximum range,  $R_{max}$ , is equal to the radar horizon or a little shorter. The radar horizon is longer than the optical one by about 6% because of the diffraction property of the radar signal. The  $R_{max}$  is given in the following equation.

$$R_{max} = 2.2 \times (\sqrt{h_1} + \sqrt{h_2})$$

where  $R_{max}$ : Radar horizon (n. mile)  
 $h_1$  : Antenna height (meter)  
 $h_2$  : Target height (meter)

For example, if the antenna height is 9 meters and the target height is 16 meters, the maximum radar range is;

$$R_{max} = 2.2 \times (\sqrt{9} + \sqrt{16}) = 2.2 \times (3 + 4) = 15.4 \text{ (n. miles)}$$

Minimum Range

When the radar is used as a collision avoidance aid, the minimum range is of urgent concern. It is very dangerous for the target to disappear when it approaches the ship. The minimum range is determined by the transmission pulse width and the height of the antenna (vertical beam width of antenna).

2.2 Radar Resolution

Bearing Resolution

The bearing resolution is an ability to discriminate two targets which are located at the same range and close each other. It is proportional to the antenna length and reciprocally proportional to the wave length. The usual bearing resolution is 1 to 3 degrees.

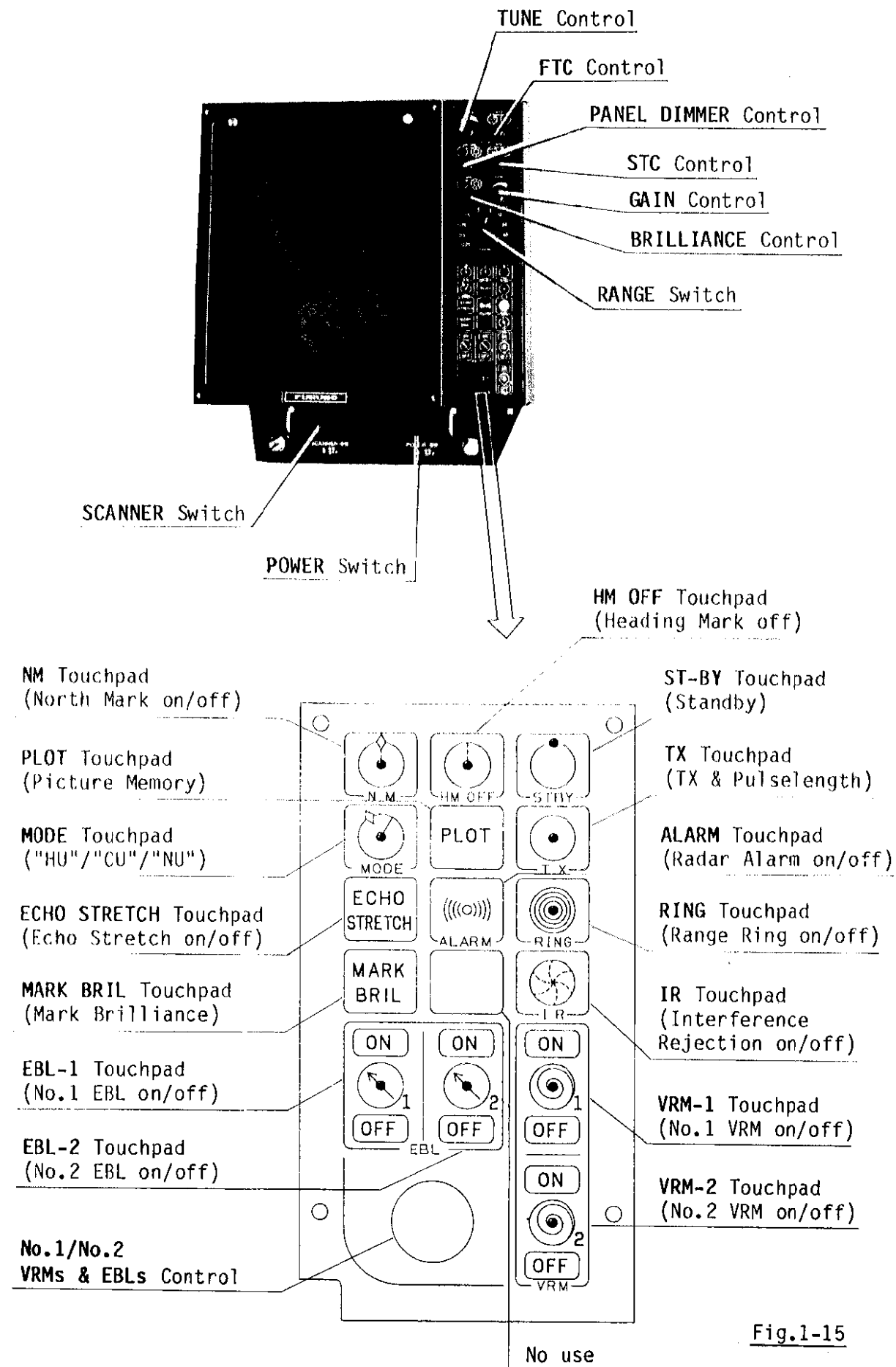

Fig.1-15

Range Discrimination

The range discrimination is an ability to distinguish two targets which are in the same direction and close each other. This is determined by pulselength only. The usual discrimination is 25 yards on 0.08 micro-second pulse.

2.3 Bearing Accuracy

One of the most important features of the radar is how accurately the bearing of the target can be measured. The accuracy of the bearing measurement basically depends on the narrowness of the radar beam. However, the bearing is usually taken relative to the ship's heading, and thus, the adjustment of heading marker at installation is an important factor to determine the bearing accuracy. When measuring the bearing of a target, put the target echo at the extreme position on the screen by selecting proper range to minimize the measuring error.

2.4 Range Measurement

Measurement of the range to the target is also very important function of the radar. Generally, there are two means of measuring range: the fixed range rings which appear on the screen with a predetermined interval as a reference of the range measurement, and the variable range marker which can be moved inwards and outwards so that it will touch the target and the range to the target can instantly be read out by the digital display.

2.5 False Echoes

Occasionally echo signals appear on the screen at positions where there is no target or disappear even if there are targets. They are, however, recognized if you understand the reason why they are represented. Typical false echoes are shown below.

Multiple Reflection

When a wide and plane target such as the sideboard of the ship, bridge, building on the pier and breakwater exists near the ship, the radar pulses are multi-reflected between your ship and the target. This results in presentation of multiple echoes on the screen. The multiple echoes appear at equal intervals after the true echo as shown in Fig.2-1.

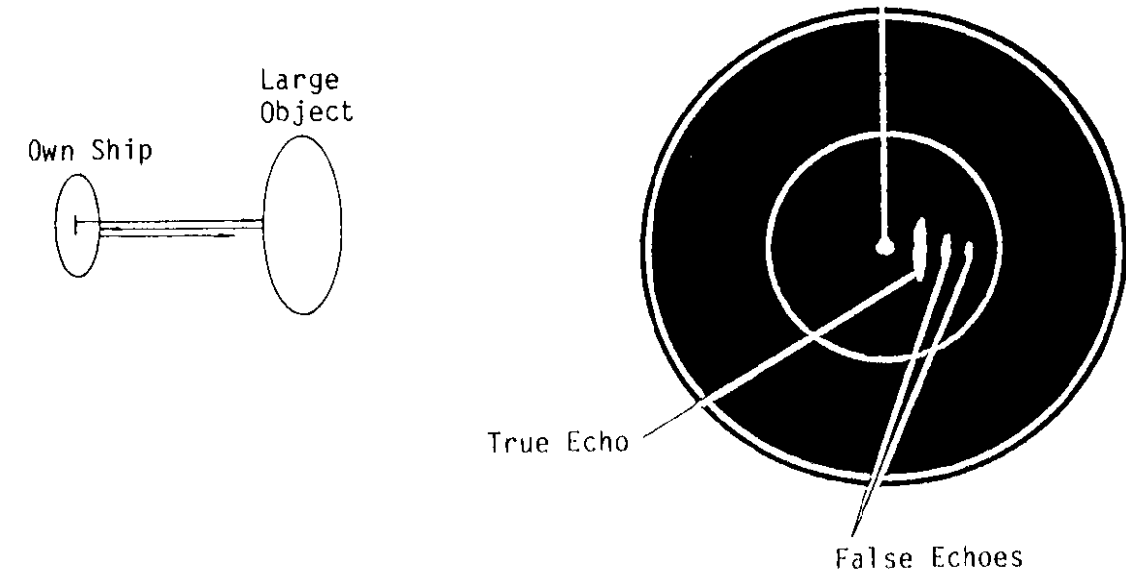

Fig.2-1

Spurious Echoes

When the radar pulse is emitted from the antenna radiator, some of the emitted total energy escapes on each side of the main beam --- sidelobes. If the target is strong, it can be detected by the sidelobes as well as main lobe, the spurious echoes may be represented at both sides of true echo with the same range as shown in Fig.2-2. The spurious echoes can also be removed by adjusting the GAIN and STC controls.

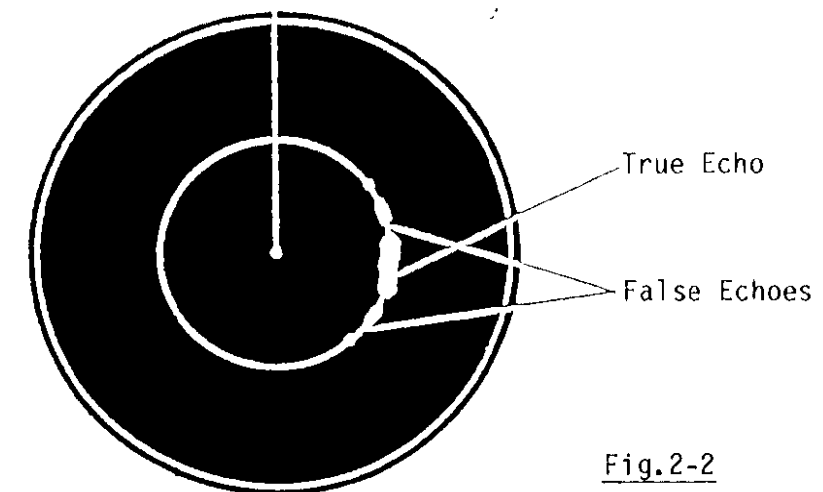

Fig.2-2

Second-trace Echoes

If the radio wave propagation is extraordinary, the echoes from very distant targets may appear on the screen. In this case, they may return after the echoes from the next transmission pulse have appeared. Thus the false echoes appear together with the true echoes of the near distant targets.



Virtual Image

A relatively large target, close to your ship, may be represented at two positions on the screen. One of them is the true echo directly reflected by the target and the other is the false echo which is caused by the mirror effect of a huge object on or close to your ship as shown in Fig.2-3. If your ship comes close to a big metallic bridge, for example, such a false echo may temporarily be seen on the scope.

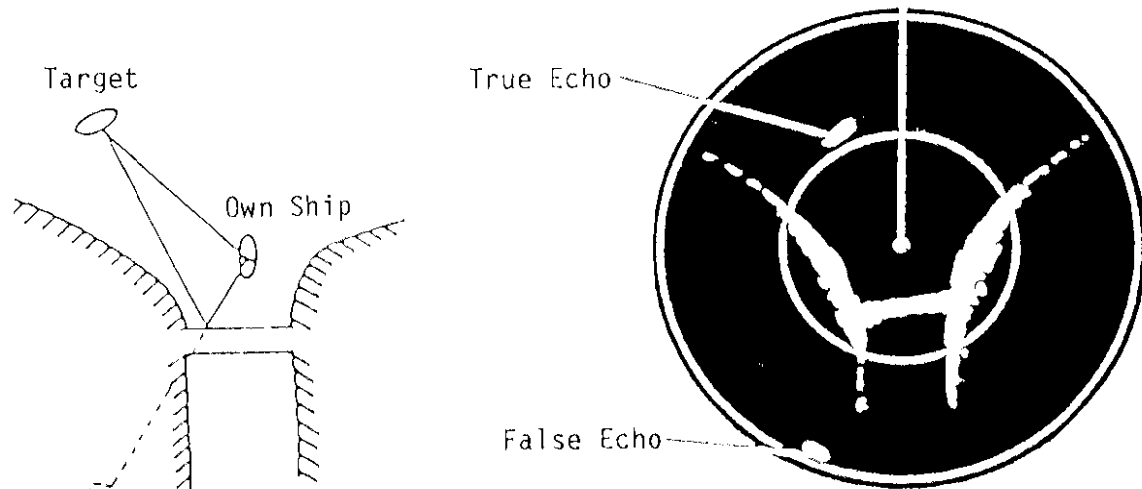

Fig.2-3

Dead Angle (Blind Sector)

A funnel, mast or derrick post near the radar antenna may intercept the radar beam. In that case, no target is detected within a certain angle, and it is called "dead angle". The huge object close to your ship may cause the similar result.

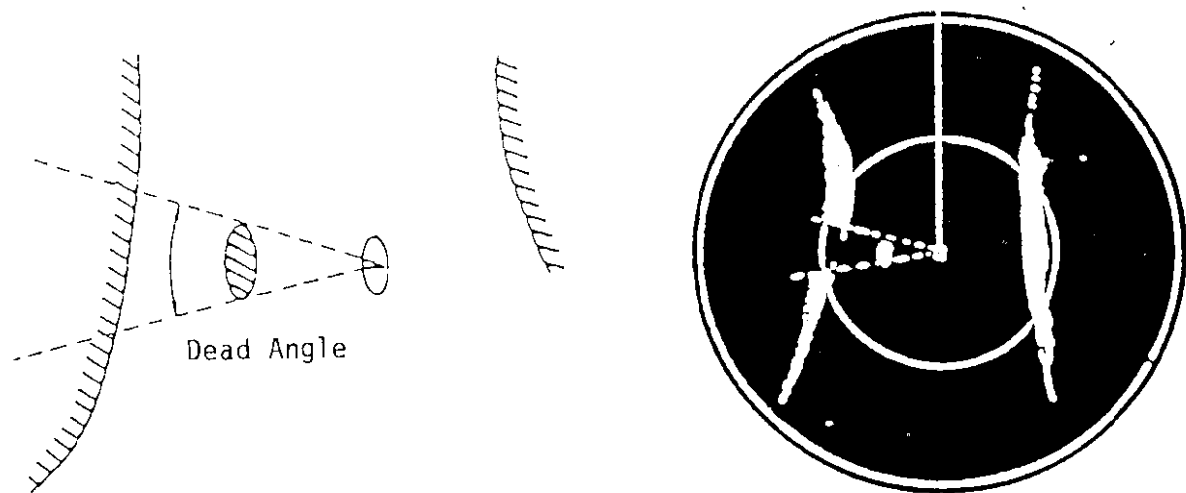

Fig.2-4

Radar Interference

When another ship is using the same frequency as your ship, the radar pulses emitted from another ship are received and appear on your radar screen as the curved spokes as shown in Fig.2-5.

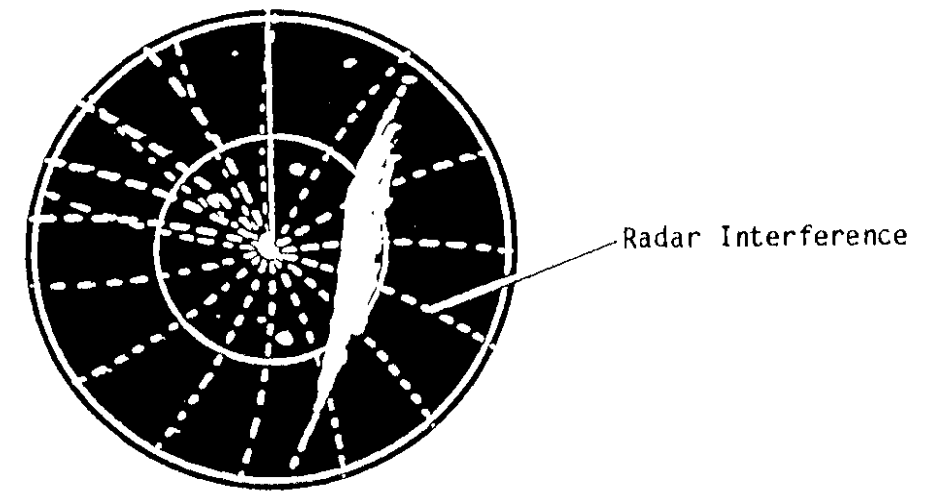

Fig.2-5

CHAPTER 3 MAINTENANCE

To maintain optimum performance of the equipment for extended period, general check and maintenance should be made periodically.

"CAUTION"

Before maintenance work, be sure to switch off the radar at main switch-board. When checking inside the units, wait for a few minutes until the high voltage components (CRT or HV capacitors) can discharge the residual charge.

On checking the inside of the scanner unit, turn off the scanner safety switch. See Fig.3-1.

Interval	Item	Check/Measures	Remarks
3 to 6 months	Exposed bolts and nuts on scanner unit	Check for corroded or loosened bolts/nuts. If necessary, clean them up and repaint thickly. Replace them with new ones if heavily corroded.	*Sealing compound may be used instead of paint.  *Put slight amount of grease if bolts and nuts are replaced.
	Scanner radiator	Check for dirt or crack on the radiator surface. Thick dirt should be wiped off by using a soft cloth immersed in fresh water. If any crack is found, apply slight amount of sealing compound or adhesive as first-aid treatment, then call for repair.	*Do NOT use plastic solvent (thinners or acetone) for cleaning.  *When removing ice on the scanner unit, use wooden hammer or plastic-head hammer. Crack on the scanner unit will cause permanent damage to the internal circuitry due to water leakage.
	Terminal boards and plugs in scanner unit (See Fig.3-1.)	Remove scanner covers to check terminal board/plug connections inside. Also check if the packing on each cover is in good order.	*When putting covers back in positions, do not pinch flying wires.
	CRT screen	Dirt on this creates symptom identical to poor sensitivity. Clean up CRT surface using special care not to scratch them.	*Use soft cloth with slight amount of anti-static-charge spray. Never apply plastic solvent.

Interval	Item	Check/Measures	Remarks
6 months to 1 year	Scanner motor (See Fig.3-2.)	Check and clean up carbon brushes and commutator. If brushes have worn out to 6mm or less, replace them with new ones. (New brush is 11mm long.)	*Under normal use, the carbon brush will last approximately 2000 hours.
	CRT anode and approach (See Fig.3-3.)	High tension on CRT attracts dust in environment, and moist dust will cause poor insulation. Clean up high voltage parts as follows.  1. Turn off radar.  2. Pull out anode cap and touch its nipple to chassis (discharging).  3. Clean up CRT side and anode cap/lead by using soft dry cloth.	*If any crack is found on rubber cap or wire sheath, replace it with new one.  *Always make sure to put anode cap back on CRT after cleaning.
	Terminal boards, sockets and plugs	Check for loose connections. Polish up contacts or replace plug, if necessary.	
	Scanner turning gear (See Fig.3-2.)	Check that scanner turning gear is greased. If not, apply a generous amount of grease to the gear.	

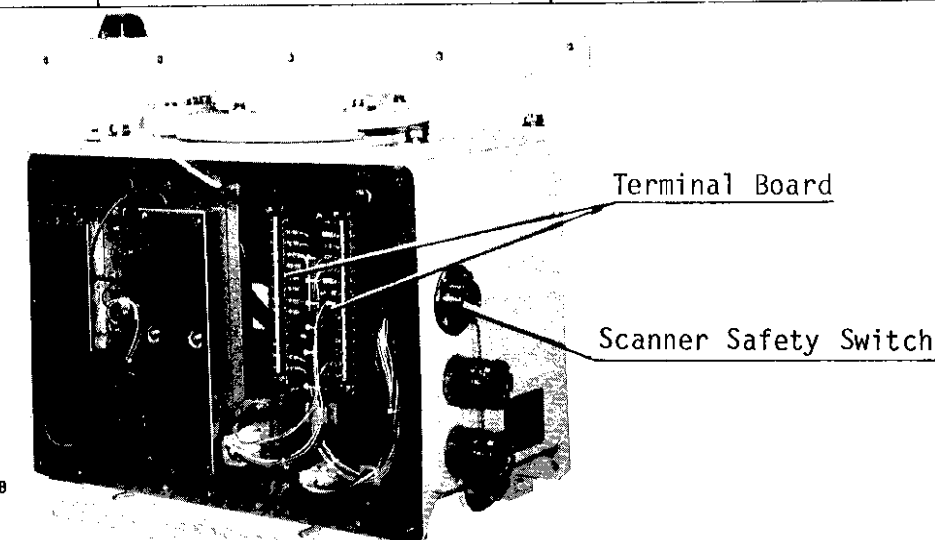

N Photo No.2078

Fig.3-1 Port View of Scanner Unit without Cover

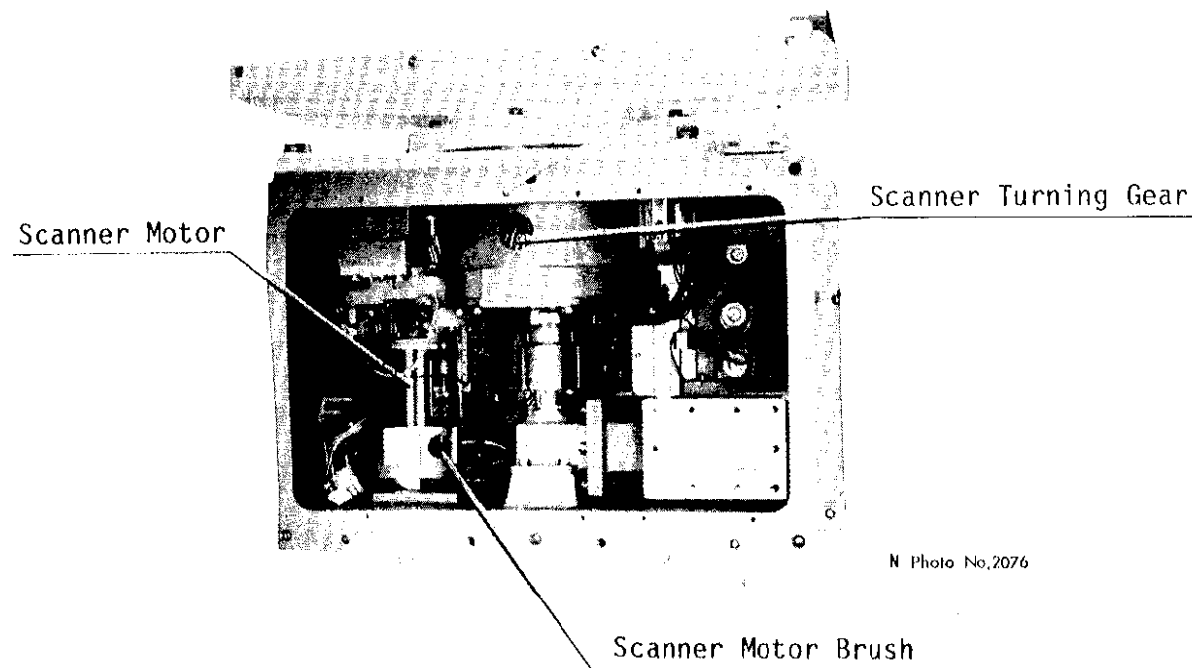

Fig.3-2 Starboard View of Scanner Unit without TX Module

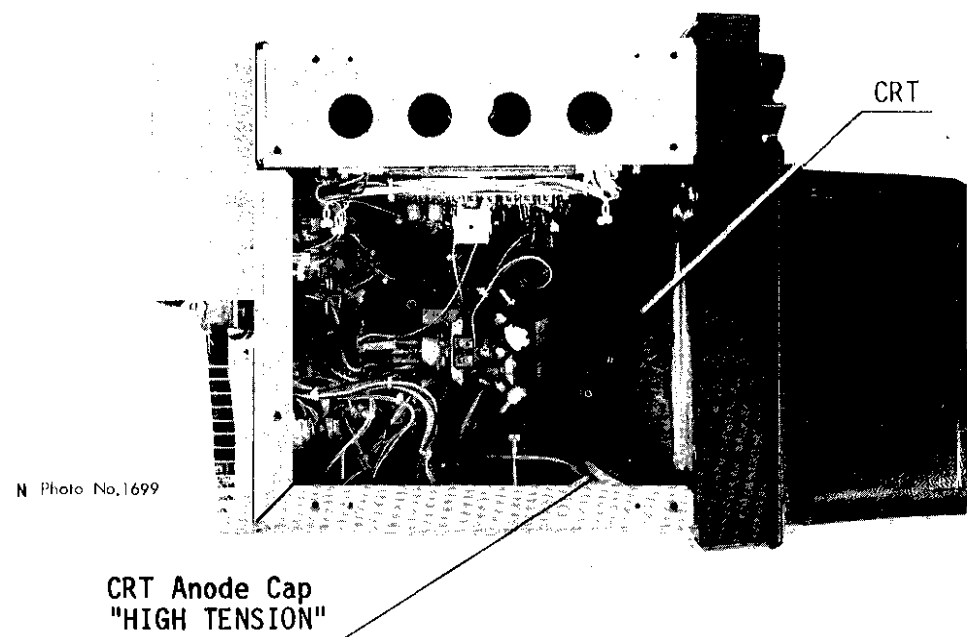

Fig.3-3 Top View of Display Unit without GSC Board

CHAPTER 4 TROUBLESHOOTING

4.1 Self-check for Memory Device

Whenever an unusual symptom is encountered, check ROM/RAM operation on the CPU board (03P5550). Upon turning on the radar, the check result of the ROM/RAM is displayed at the bottom of the screen. See Fig.4-1. If abnormal operation is detected, an error message such as "ROM 1 ERROR" appears. Replace a chip indicated by "ERROR" with new one. See Fig.4-2 for parts location. If ROM/RAM operation is OK, check the plug connections on p.c. boards and the lead connections on terminal boards, then proceed to individual function check along with the Trouble Finding List on page 4-3. If some board is found to be faulty, replace it with new one or call for service. Do not attempt further component check in the p.c. board. Careless handling may cause more serious trouble.

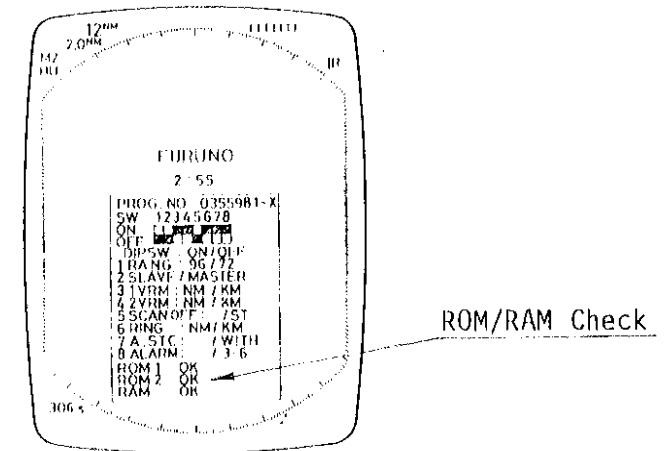

Fig.4-1

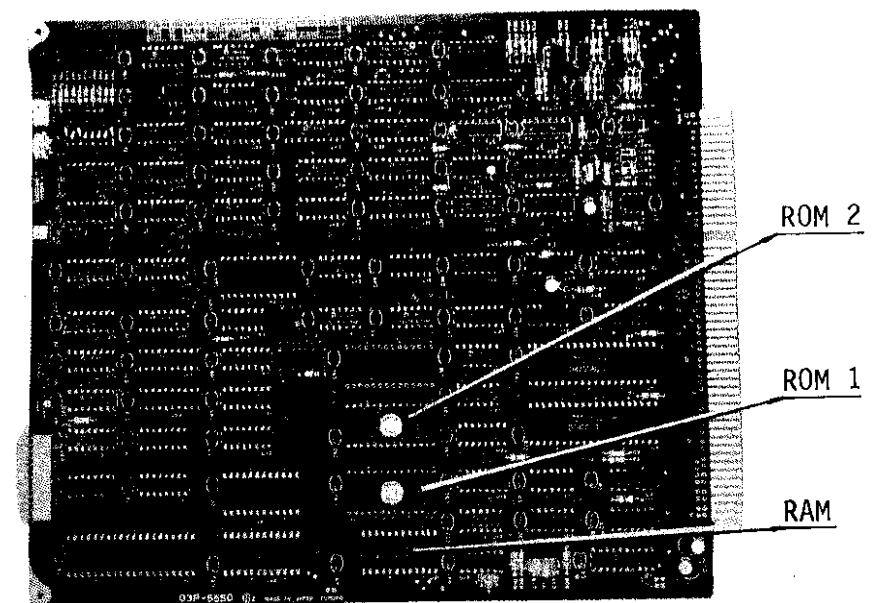

Fig.4-2 CPU Board (03P5550)

N Photo No.1703

"CAUTION"

There are many high tension points in the radar system. Take special care when approaching the following parts.

1. Power supply circuit (Display Unit)
2. CRT circuit (Display Unit)
3. Modulator circuit (Scanner Unit)
4. Magnetron (Scanner Unit)

Notes on Service Call

To allow effective service job, the following information should be given at a service call.

1. Name of the vessel
2. Vessel's position (port/berth)
3. Sailing Schedule
4. Radar model
5. Serial number/Date manufactured
6. Symptom of trouble  
(Results of checks along with the Trouble Finding List)
7. Previous service

4.2 Trouble Finding List

Operation	Symptom	Check Point	Remarks
Turn on POWER switch and adjust PANEL DIMMER control.	Illumination lamps for front panel do not come on with PANEL DIMMER turned fully CW.	<ol style="list-style-type: none"> <li>1. Main fuse F1351 (Display rear) See Fig.4-3.</li> <li>2. Mains voltage/polarity</li> <li>3. Overload on some voltage line(s)</li> <li>4. POWER SUPPLY board</li> <li>5. Illumination lamps</li> </ol>	<p>*Measure mains voltage at DTB-I #1(+) and 2(-). See Fig.4-3. The voltage should be 20.4 to 31.2VDC.</p> <p>*If some voltage line is overloaded (or shorted), inverter oscillation stops (CR11 thru CR16 on POWER SUPPLY board go off.) and CR10 on the board keeps lighting. See Fig.4-6. Turn off the radar and turn it on again observing CR11 thru CR16 (LEDs). The LEDs for normal lines light up momentarily before inverter oscillation stops. Check the line corresponding to the LED which is not lit up.</p>

Continued

Operation	Symptom	Check Point	Remarks
Adjust BRILLIANCE control.	Nothing appears on CRT.	1. CRT	*Visually check that CRT heater is lit.
		2. CRT H.T.	*Turn off POWER switch and pull out CRT anode cap with special care for H.V. charged, then move it close to chassis (approx. 8mm apart). If normal, sparking will occur.
		3. DEFLECTION board	*Adjust CONTRAST pot. (RV101) and BRIGHT pot. (RV204) on DEFLECTION board. See Fig.4-7. If some picture appears, CRT assembly is OK.
		4. CPU board	*If CR9 on CPU board lights up, CPU (Z80) is in good order. See Fig.4-8.
		5. MEMORY board	
	Picture synchronization is abnormal.	1. CRT assembly (DEFLECTION board, etc.)	*Adjust V-HOLD pot. (RV202) and H-HOLD pot.(RV401) on DEFLECTION board. See Fig.4-7. If synchronization is not achieved, DEFLECTION board is defective.
		2. CPU board	* If CR9 on CPU board lights up, CPU (Z80) is in good order. See Fig.4-8.
		3. MEMORY board	

Continued

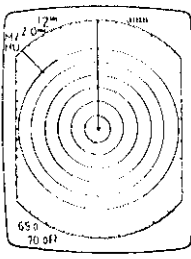
Operation	Symptom	Check Point	Remarks
Turn on SCANNER switch.	Scanner does not rotate.	1. Scanner fuse F1352 (10A) See Fig.4-3. 2. Scanner Motor brushes 3. Scanner rotating mechanism jammed 4. Scanner motor relay (Fig.4-4)	
After ST-BY message appears, press TX touchpad.	Marks and legends appear abnormally.	1. CPU board 2. MEMORY board	*If CR9 on CPU board lights up, CPU (Z80) is in good order.
Adjust GAIN control with STC set at minimum.	Marks and Legends appear but no noise nor echo. 	1. IF amplifier 2. Multicore cable between the scanner and display 3. INTERFACE board or GSC board (Fig.4-5) 4. MEMORY board	*Check continuity and isolation of coax. cable. (Note: Disconnect the plug and lugs at the both ends of coax. cable before checking it by ohmmeter.) *If CR16 does not blink on INTERFACE board, INTERFACE board or GSC board is faulty. If it blinks, MEMORY board is faulty. See Fig.4-8.

Continued

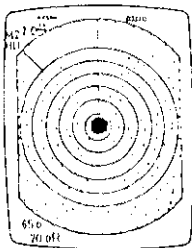
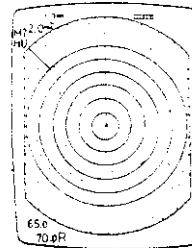
Operation	Symptom	Check Point	Remarks
	Marks, legends and noise appear but no echo. (The transmission leak appears as below.) 	1. MIC (Fig.4-9)	*Set RANGE switch at 0.25 n.m., and turn GAIN control fully CW (max.). If the center spot (transmission leak) appears on the screen, the transmitter may be operating normally.
	Marks, legends and noise appear but no echo. (No transmission leak appears.) 	1. TX fuse F1 (0.5A) See Fig.4-3. 2. Magnetron 3. MODULATOR board 4. MODULATOR TRIGGER board 5. Modulator SCR 6. CPU board 7. INTERFACE board	*Replace fuse with new one. If the fuse blows off again, the magnetron or modulator's components may be faulty.  *Connect a multimeter between pins #4(+) and #1(-) of "TEST" point on MOTHER board (Fig.4-3) and set the radar to transmit on 72 n.m.range (MAG CURR). If the voltage is within 3.0 to 5.0VDC, 2 to 5 of "Check Point" may be OK.  *Connect a multimeter set at 10VAC range between test points TX-TRIG (+) and GND (-) on INTERFACE board. If the voltage reading changes with turning RANGE switch, the CPU and INTERFACE boards in the display unit are operating normally.

Continued

Operation	Symptom	Check Point	Remarks
	Sweep rotation is not synchronized with antenna rotation.	1. BEARING SIGNAL GEN. board (Fig.4-10) 2. INTERFACE board 3. CPU board	*If CR15 on INTERFACE board (Fig.4-8) lights up every 2 to 3 sec., heading flash circuit on INTERFACE board is normal.
	Abnormal bearing of picture	1. Adjustment of the heading SW on CPU board. See page AP1-27. 2. CPU board 3. Gyro Interface board	
Adjust TUNE control.	Poor sensitivity	1. Deteriorated Magnetron 2. Detuned MIC 3. Dirt on Radiator face	*Set RANGE switch to 72 n.mile detecting range, and measure voltage between pins #4(+) and #1 (-) of "TEST" point on MOTHER board (MAG CURR). See Fig.4-3. If the voltage is too low, magnetron is deteriorated. Refer to "Remarks" on page 4-6.
	Poor sensitivity (Bright circle appears on 0.25 n.mile range.)	1. Water leak on waveguide	

Continued

Operation	Symptom	Check Point	Remarks
Adjust FTC control.	No FTC effect	1. INTERFACE board	
Change RANGE switch to another position.	Radar picture is not changed.	1. CONTROL PANEL board (Fig.4-8) 2. CPU board 3. INTERFACE board	*If CR9 on CPU board lights up, CPU (Z80) is in good order.
Press IR touchpad.	Interference Rejection is not performed. (No IR legend appears.)	1. Bad contact of touchpad key 2. CPU board 3. INTERFACE board	*If CR9 on CPU board lights up, CPU (Z80) is in good order.
Press ECHO STRETCH touchpad.	No Echo Stretch function	1. Bad contact of touchpad key 2. CPU board 3. INTERFACE board	*If CR9 on CPU board lights up, CPU (Z80) is in good order.
Press RING touchpad.	No range ring	1. Bad contact of touchpad key 2. CPU board 3. MEMORY board	*If CR9 on CPU board lights up, CPU (Z80) is in good order.

NOTE: If the touchpad keys other than mentioned above malfunction, first check the contact of the corresponding touchpad. If it is OK, CPU or MEMORY board may be faulty.

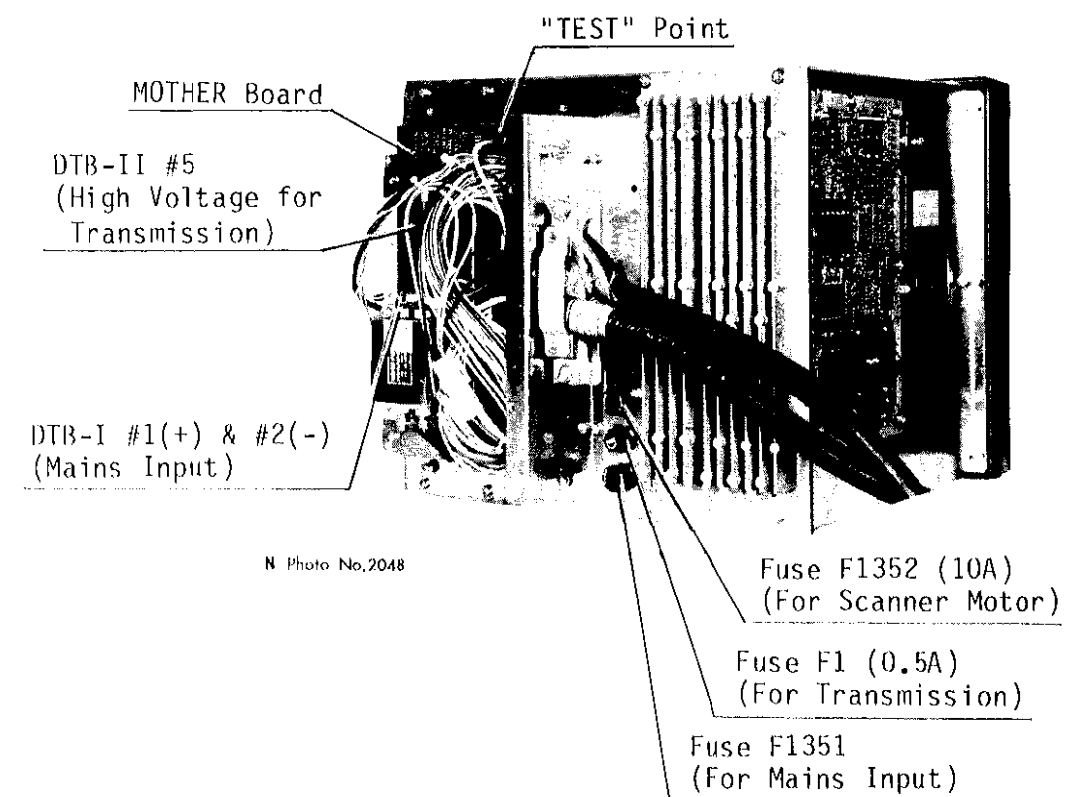
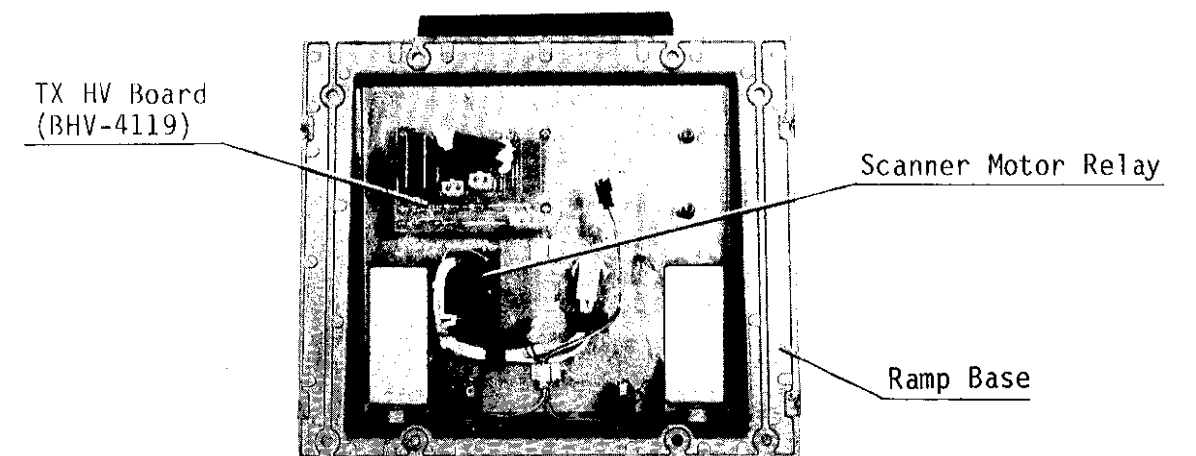
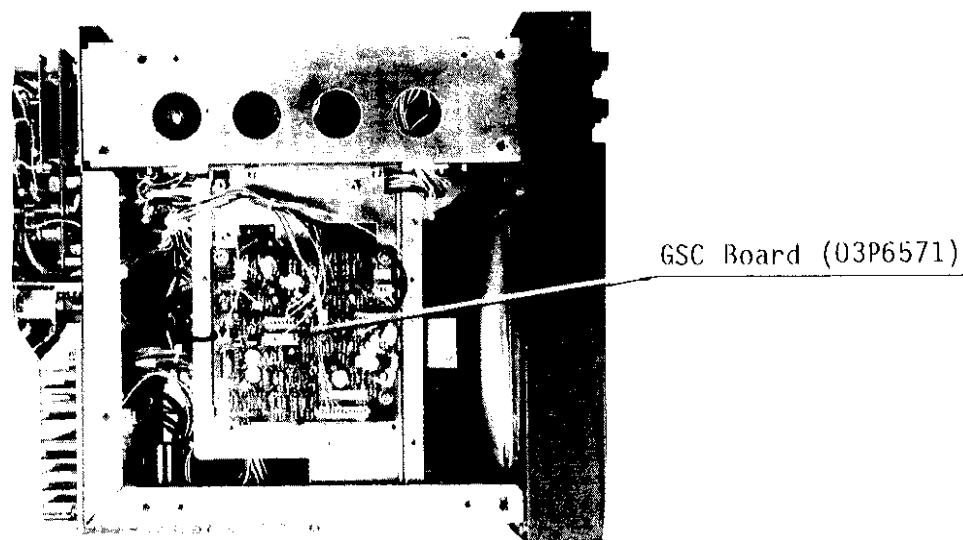

Fig.4-3 Display Unit Rear View



N Photo No,2050

Fig.4-4 Ramp Base Top View without Display Unit



N Photo No.2049

Fig.4-5 Display Unit Top View

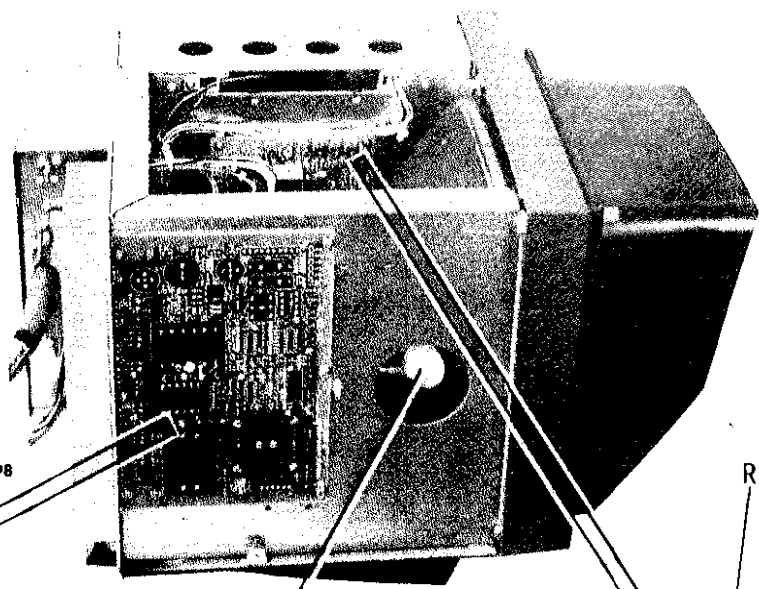

N Photo No.1698

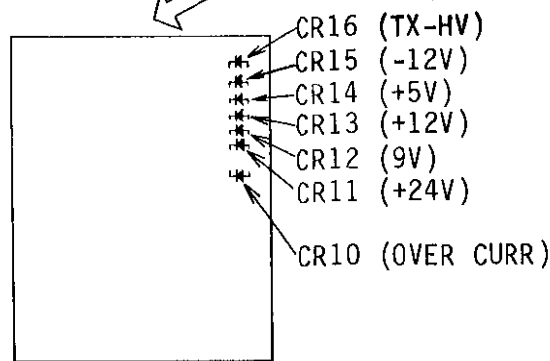

Fig.4-6 POWER SUPPLY Board Soldering Side (03P5620)

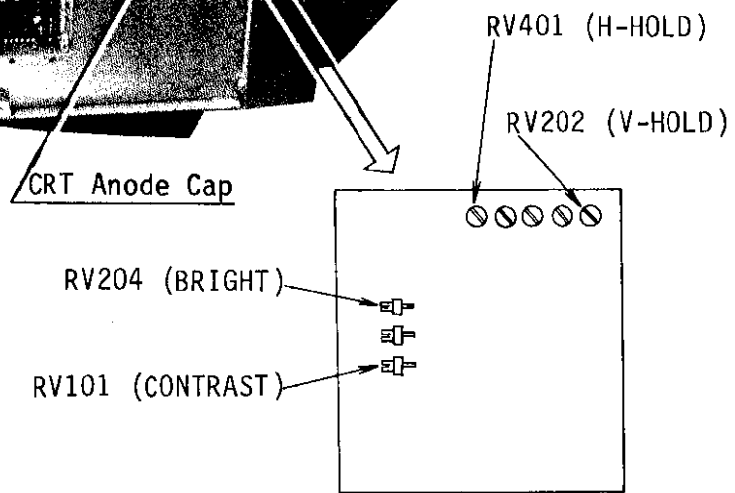
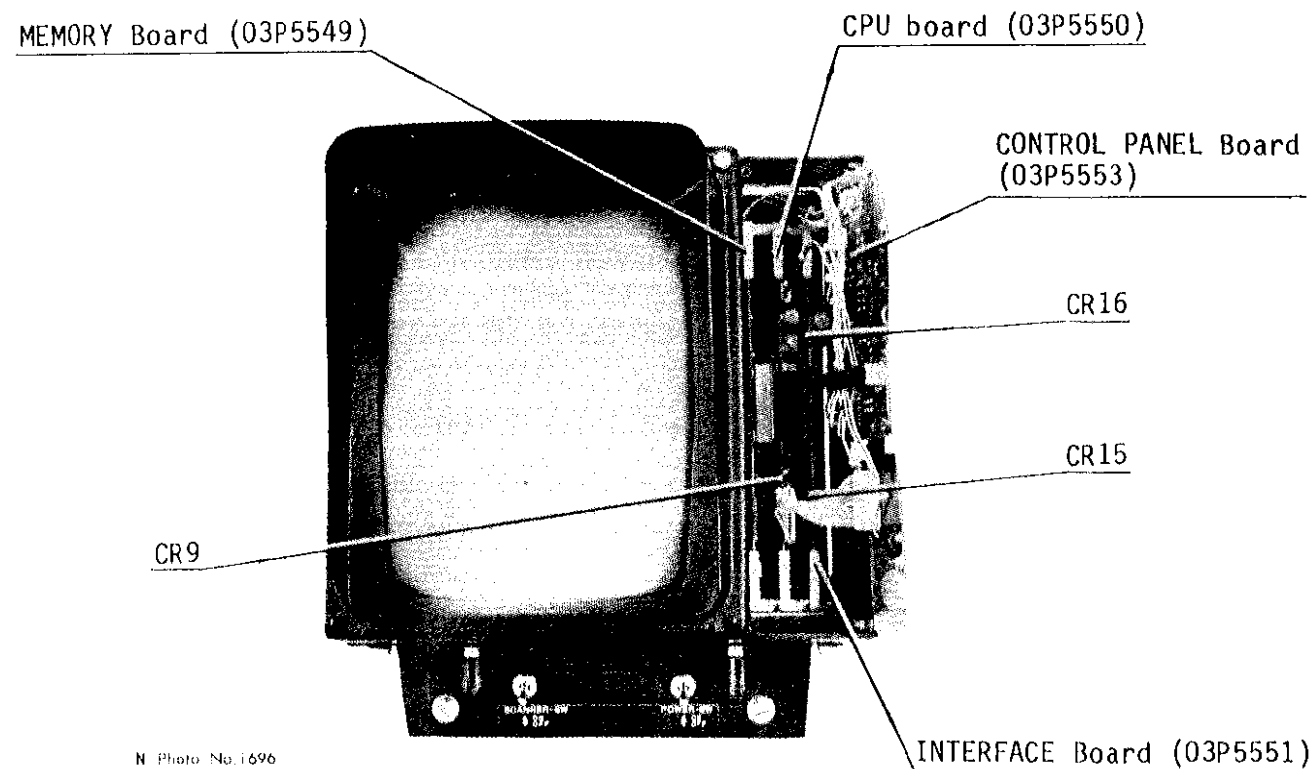

Fig.4-7 DEFLECTION Board



N Photo No.1696

Fig.4-8



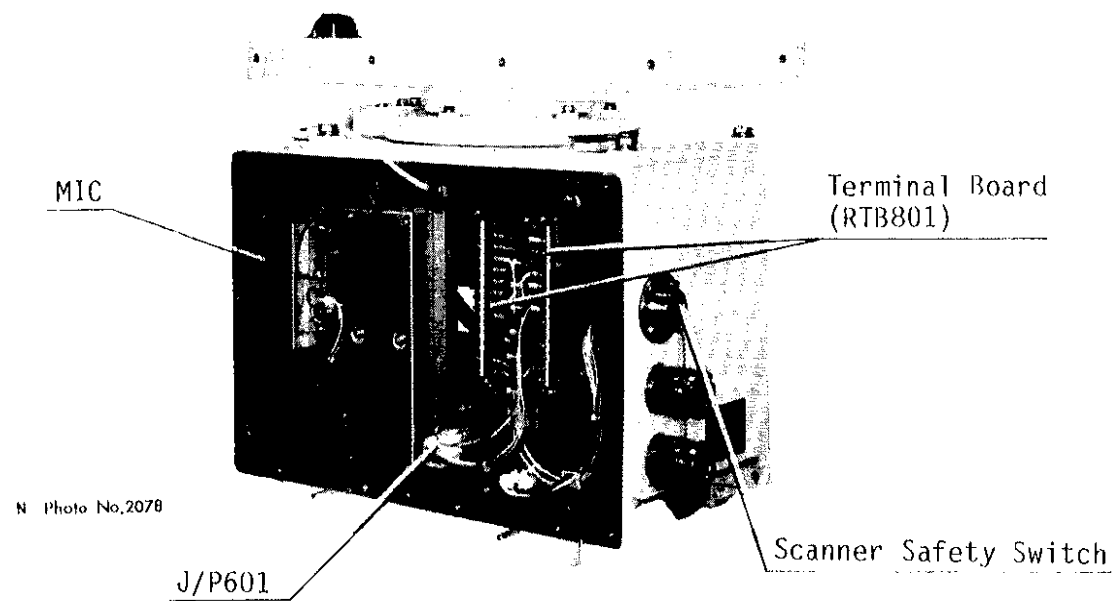

Fig.4-9 Port View of Scanner Unit

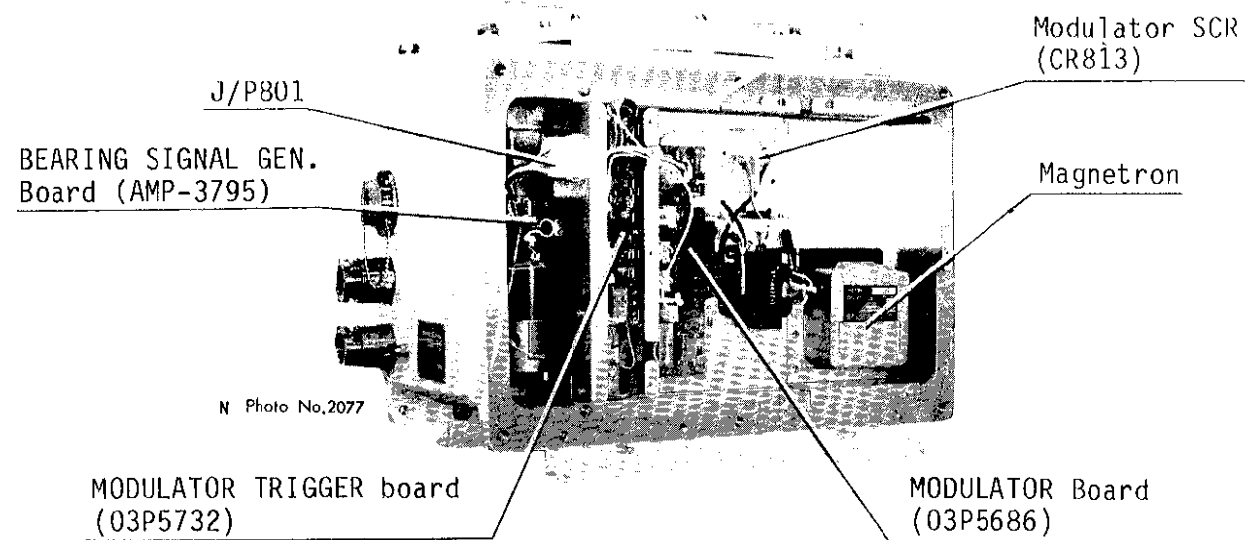
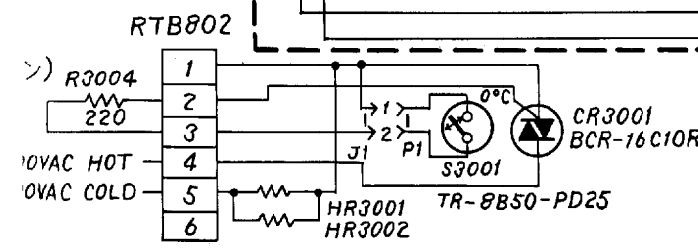
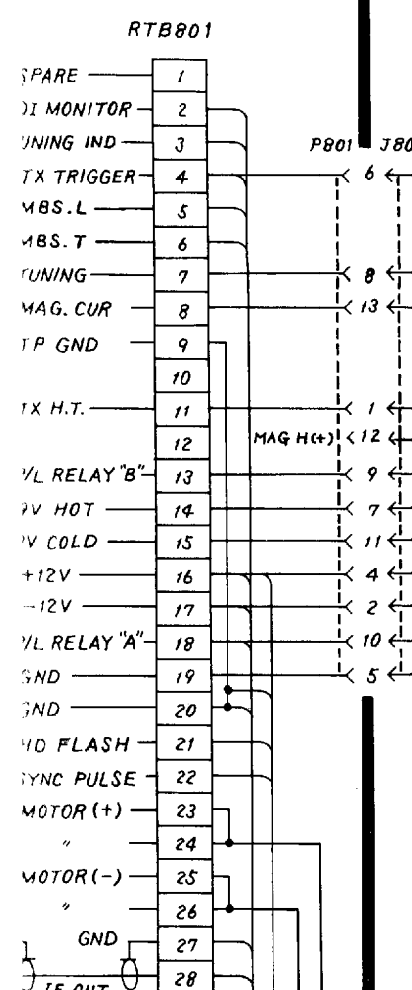
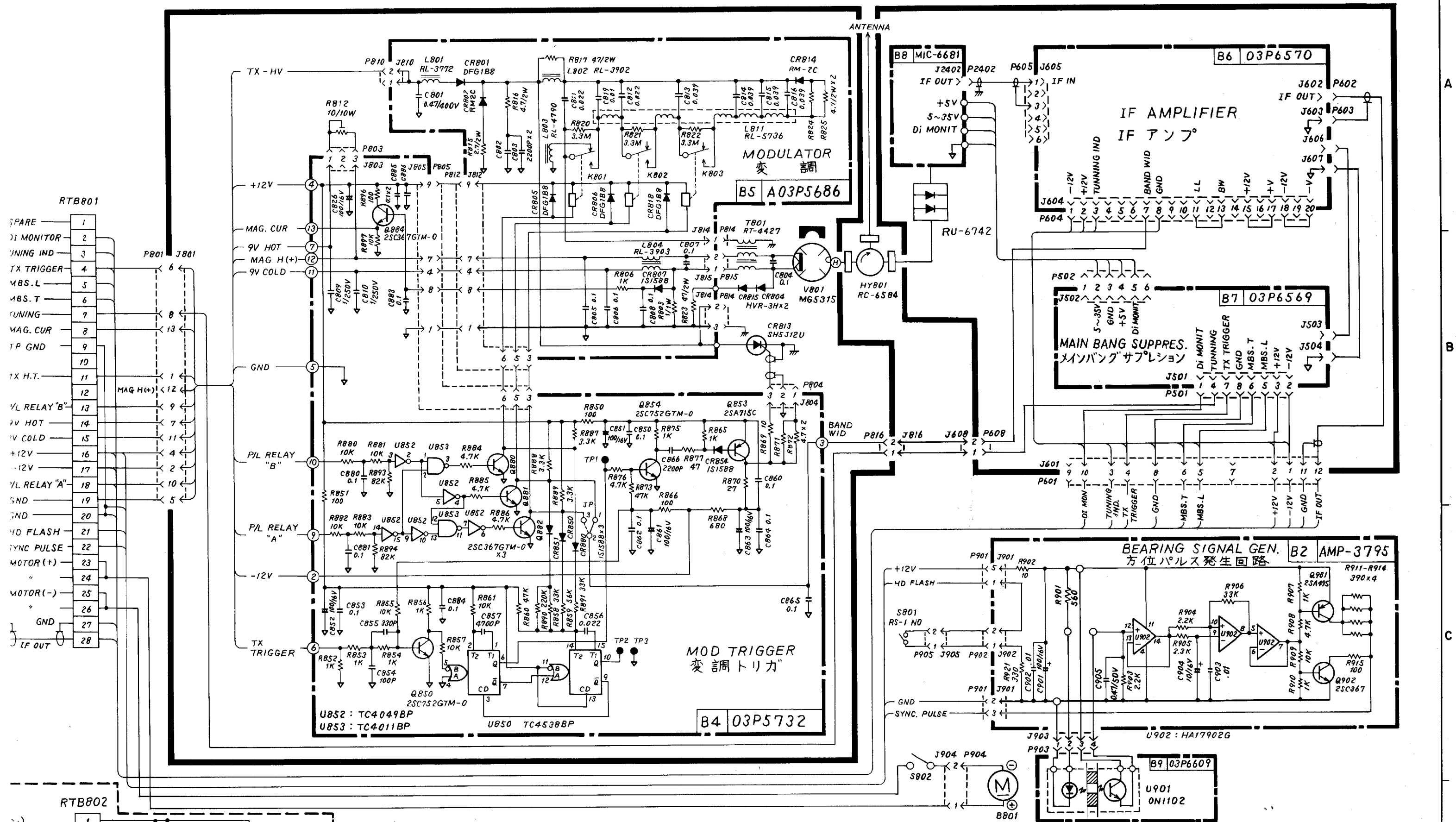

Fig.4-10 Starboard View of Scanner Unit

CONTENTS OF SCHEMATIC DIAGRAMS

No.	Items	Type	Dwg. No.	Page
1	Scanner Unit		C3291-005	S-1
2	IF Amplifier	03P6570	C3291-006	S-2
3	MBS Board	03P6569	C3291-003	S-3
4	Display Unit		C3291-001	S-4
5	Mother Board	03P5552	C3276-007	S-5
6	Power Supply Boards	03P5620 & 03P5621	C3276-006	S-6
7	TX HV Board	BHV-4119	C3259-010	S-7
8	Control Panel Board	03P5553	C3276-004	S-8
9	Touchpad Key Board	03P5554	C3276-003	S-9
10	CRT Display	MG-1250SFR	C3276-008	S-10
11	GSC Board	03P6571	C3291-014	S-11



承認 APPROVED	<i>[Signature]</i>	三角法 THIRD ANGLE PROJECTION	名称 TITLE	SCANNER UNIT 空中線部
検図 CHECKED	<i>[Signature]</i>	尺度 SCALE	重量 WEIGHT	kg
製図 DRAWN	<i>[Signature]</i>	重量 WEIGHT	kg	図番 DWG. NO.
FR-810DS			C3291-005-D	

A

B

C

D

(DISPLAY UNIT 指示部)

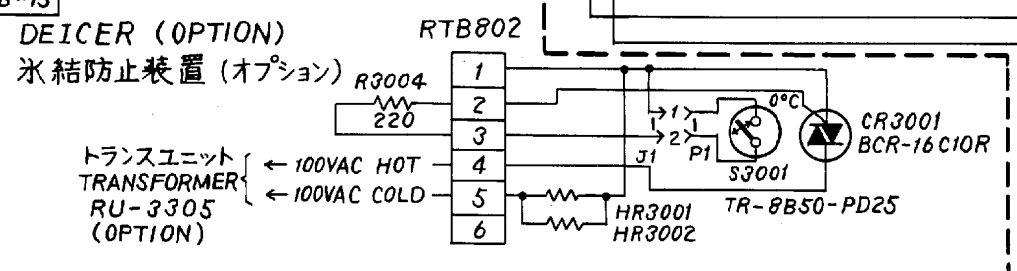
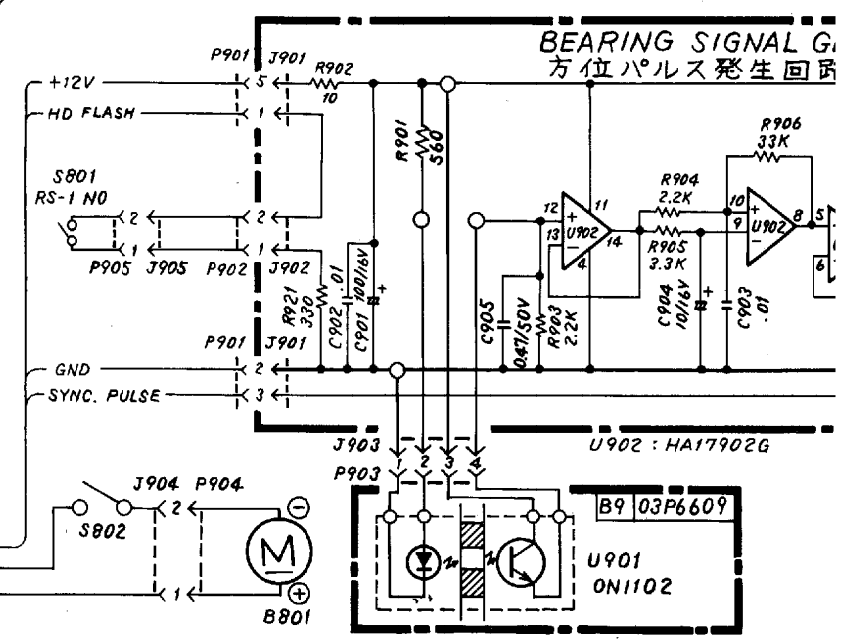
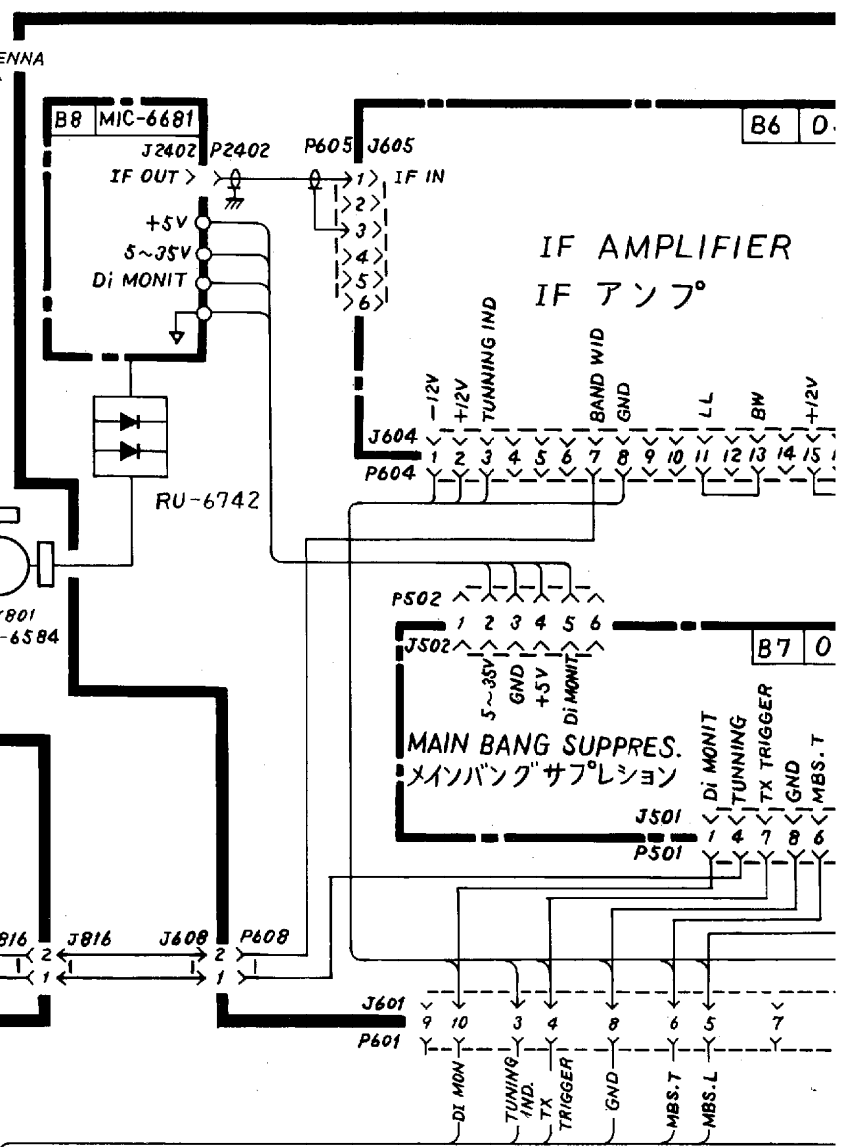
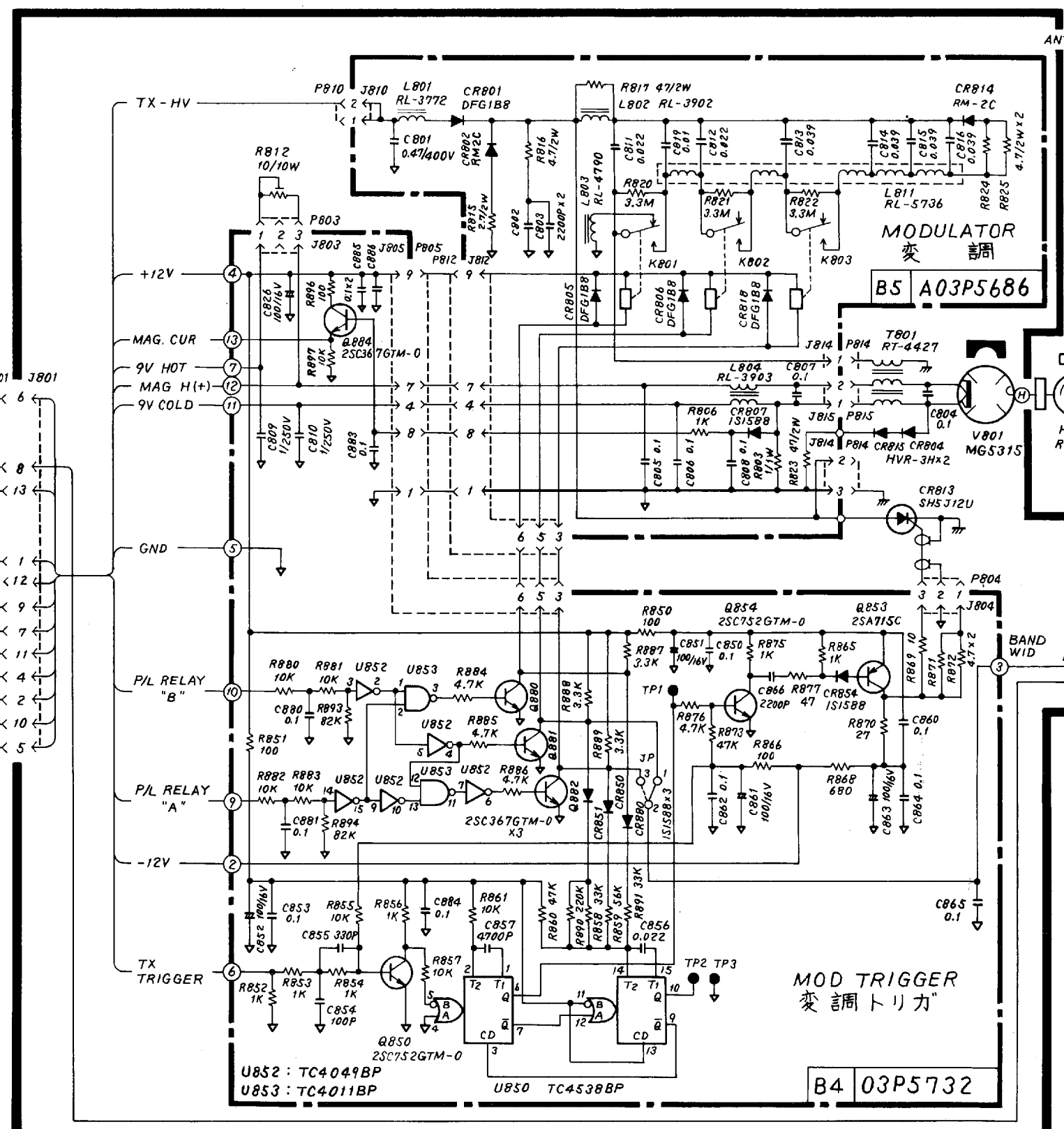
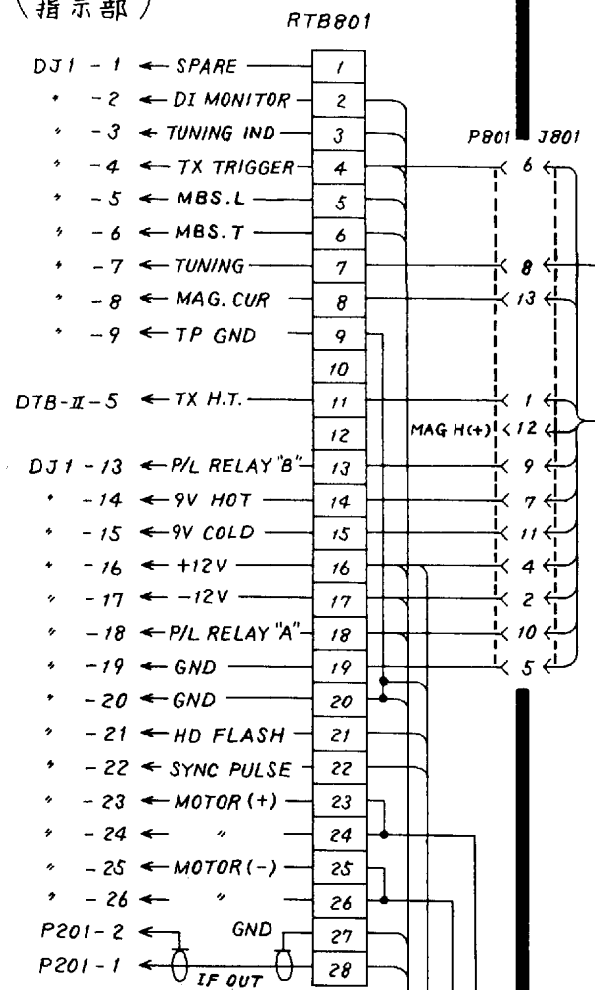

承認 APPROVED	DEC 18 '84	三角法 THIRD ANGLE PROJECTION	名称 TITLE	SC
検図 CHECKED	DEC 14 '84	尺度 SCALE		
製図 DRAWN	14 DEC 84 Tami	重量 WEIGHT	kg	番 DWG. NO. C

FR-810DS

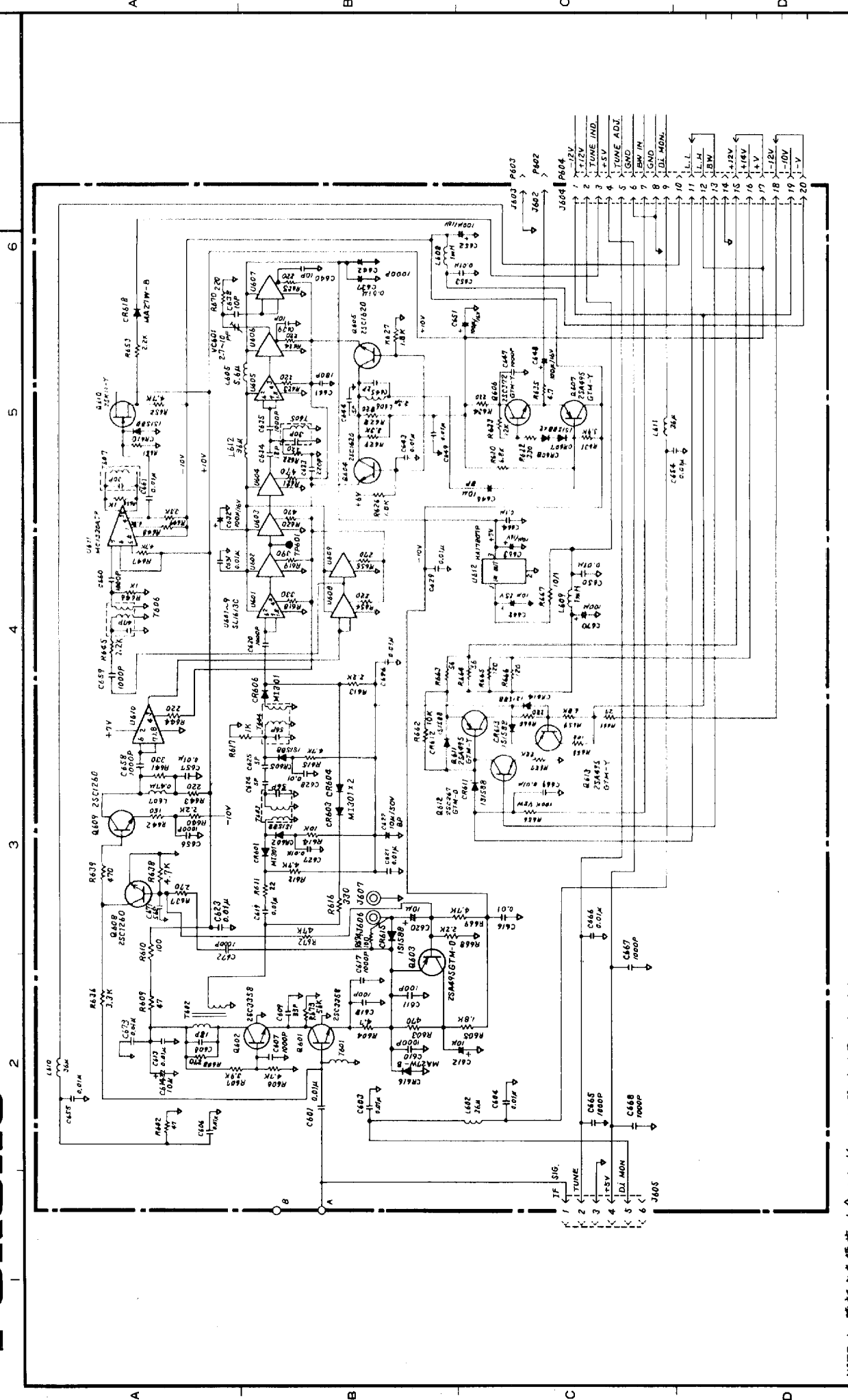

承認 1988.10.18  
 検 1988.12.18  
 製 1988.14.18

APPROVED  
 CHECKED  
 DRAWN

FR-810DS  
 REV. 1/78

品番 03P6570  
 名称 IF アンプ基板  
 TITLE IF AMPLIFIER BOARD  
 DWG. NO. C3291-006-C  
 FURUNO ELECTRIC CO., LTD.

NOTE 1. 耐電圧抵抗は全てΩ, 1/4W コンデンサはF, コイルはH.  
 ALL RESISTANCE IN OHMS 1/4W, CAPACITANCE IN FARAD  
 AND INDUCTANCE IN HENRY UNLESS NOTED OTHERWISE.

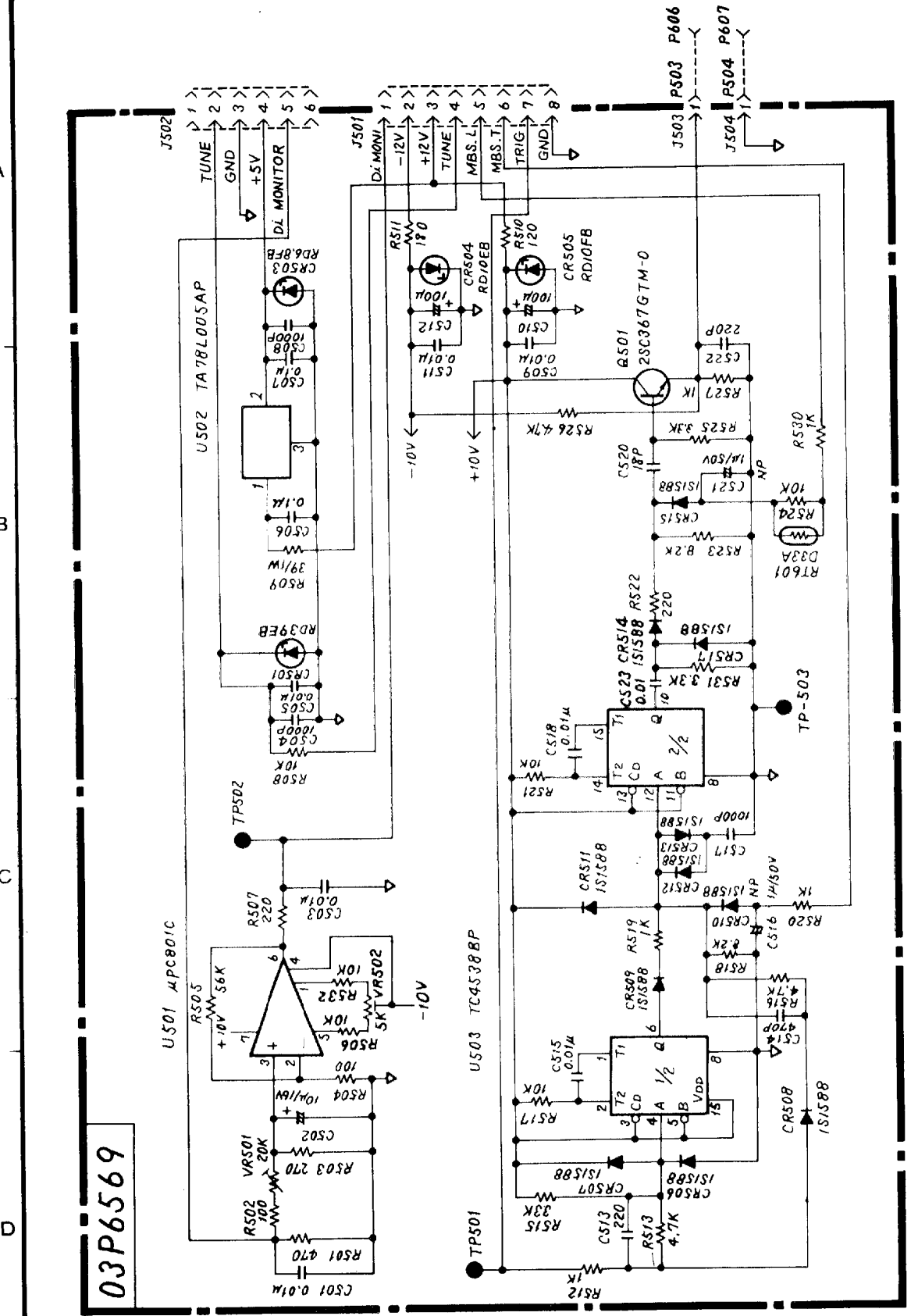

FR-810DS		品番	品名	材質	数量	番	摘要
		ITEM	NAME	MATERIAL	Q'TY	DWG. NO.	REMARKS
承認	APR. 10. '88	三角法		名称 03P6569			
検	FEB. 16. '88	THIRD ANGLE PROJECTION		TITLE メインバングサプレッション基板			
製	FEB. 14. '88	尺度	重量	MAIN BANG SUPPRESSION BOARD			
		SCALE	kg	DWG. NO. C3291-003-A			
		WEIGHT	FURUNO ELECTRIC CO., LTD.				

NOTE: 特記なき抵抗の単位は全てΩ, 1/4W コンデンサはF.  
 ALL RESISTANCE IN OHMS, 1/4W AND CAPACITANCE  
 IN MICROFARADS UNLESS NOTED OTHERWISE.

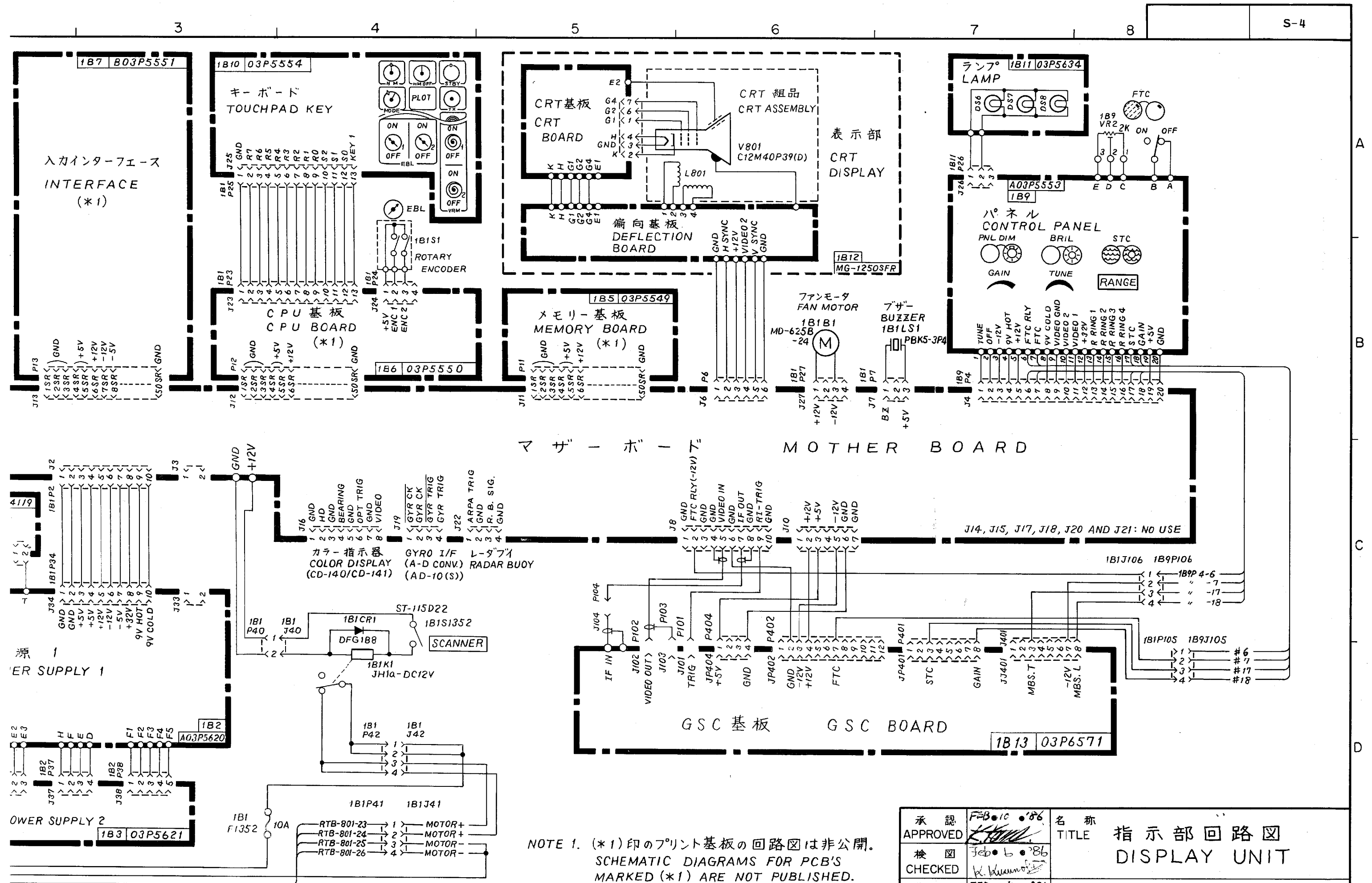

NOTE 1. (\*1)印のプリント基板の回路図は非公開。  
SCHEMATIC DIAGRAMS FOR PCB'S MARKED (\*1) ARE NOT PUBLISHED.

FR-810DS

承認 APPROVED	FEB. 10 '86	名称 TITLE	指示部回路図 DISPLAY UNIT
検図 CHECKED	Feb. 6 '86	図番 DWG. NO.	C3291-001-D
製図 DRAWN	FEB. 4 '86		

REV. : 9/86

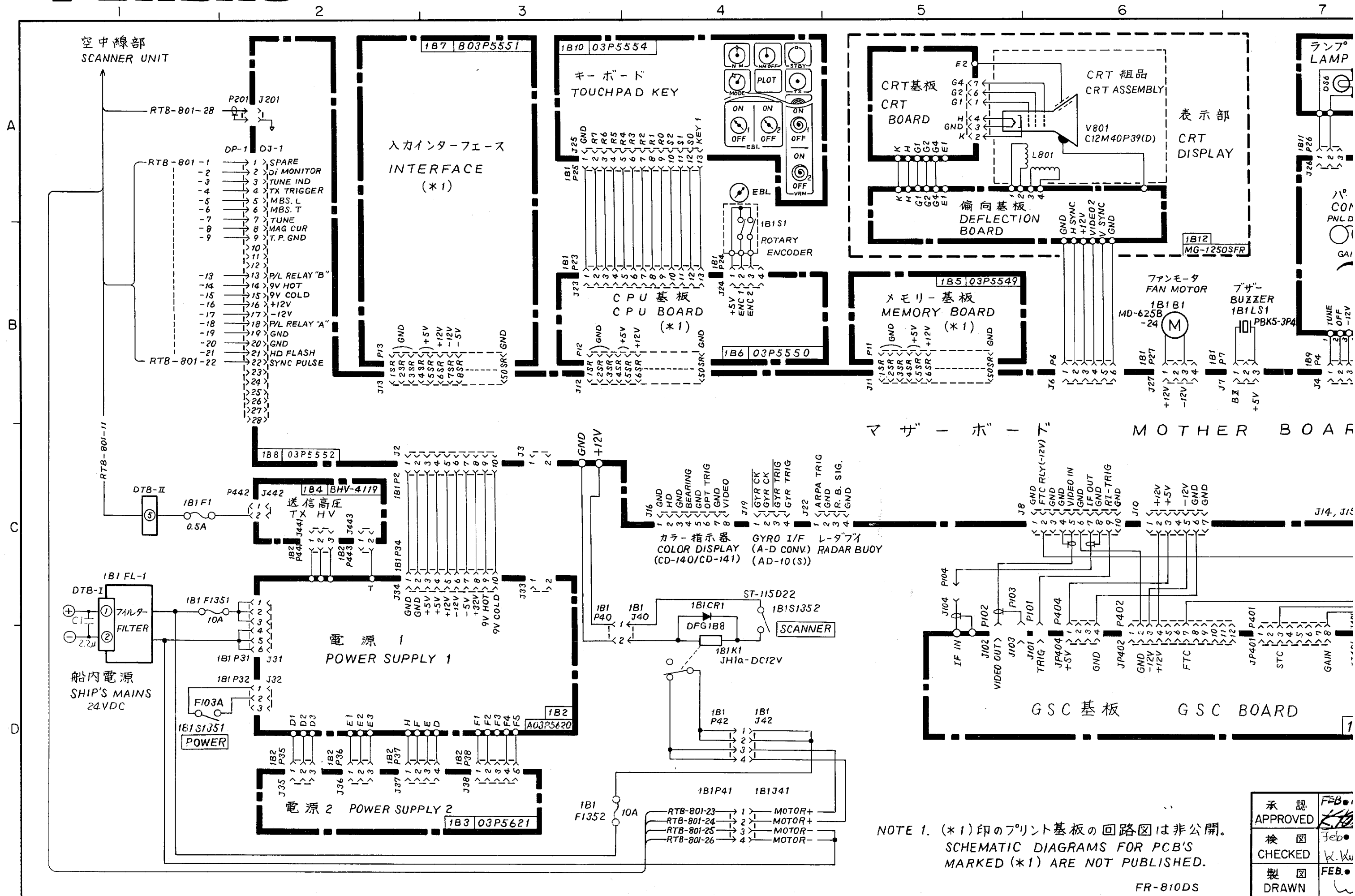

NOTE 1. (\*1)印のプリント基板の回路図は非公開。  
SCHEMATIC DIAGRAMS FOR PCB'S MARKED (\*1) ARE NOT PUBLISHED.

承認 APPROVED	FEB. 01
検図 CHECKED	Feb. 01
製図 DRAWN	FEB. 01

FR-810DS

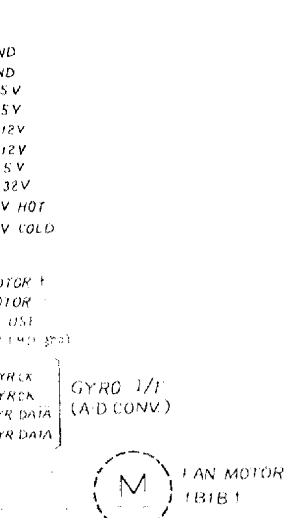
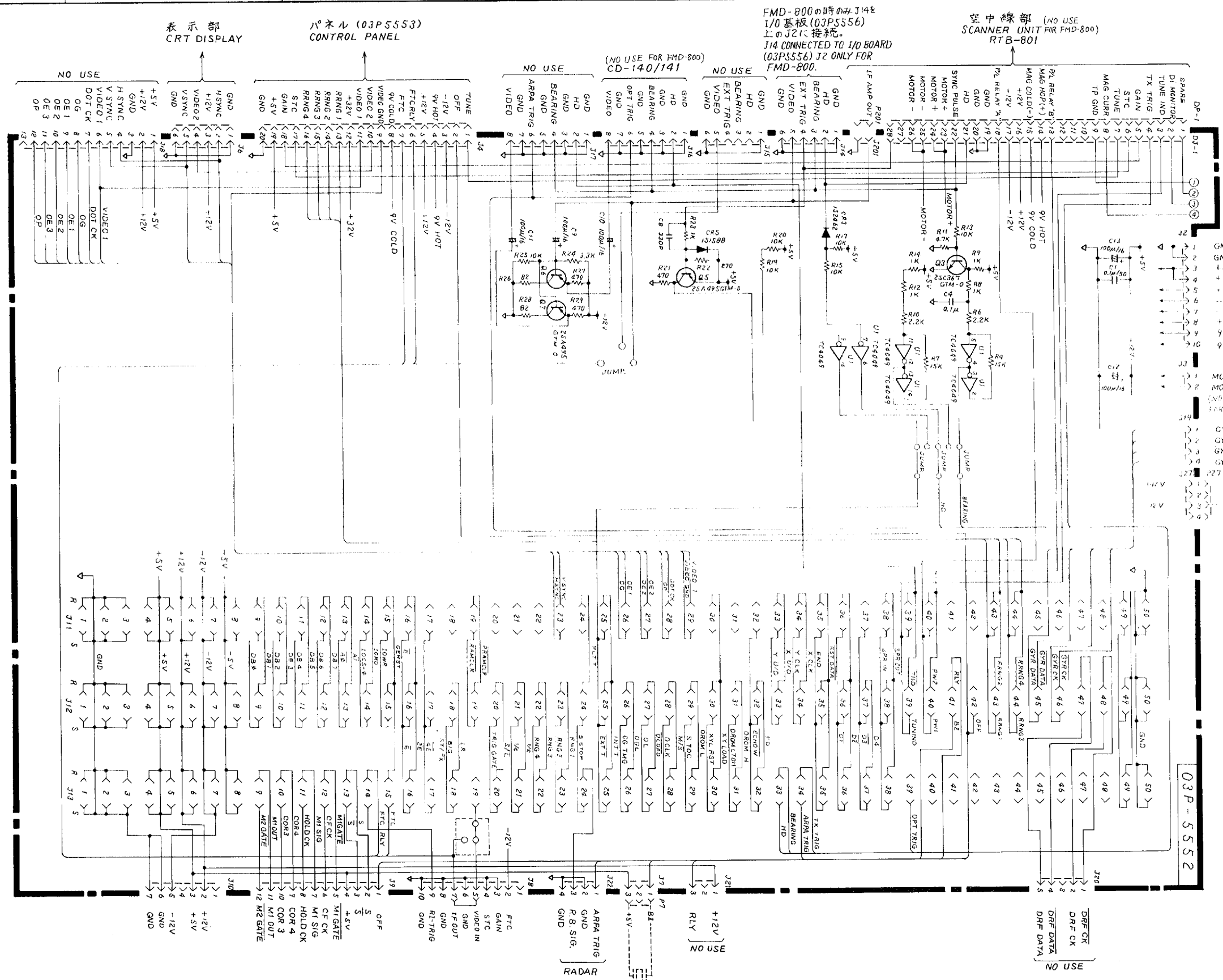

A  
B  
C  
D  
E

A  
B  
C  
D  
E

NOTE 1: 特記なき抵抗の単位は全てΩ, 0.25W, x コンデンサは F.  
 ALL RESISTANCE IN OHMS, 0.25W, AND CAPACITANCE IN FARADS UNLESS NOTED OTHERWISE.

PARTS NO. 188 ---

FMD-800  
 FR-810DS  
 FR-825D(A)  
 FR-805D(A)/810D(A)

承認 APPROVED	DEC-6-84	名称 TITLE	マザーボード MOTHER BOARD
検図 CHECKED	DEC-5-84	製図 DRAWN	図番 DWG. NO.
製図 DRAWN	DEC-5-84		C3276-007-G

REV: 5/85, 10/85, 5/86

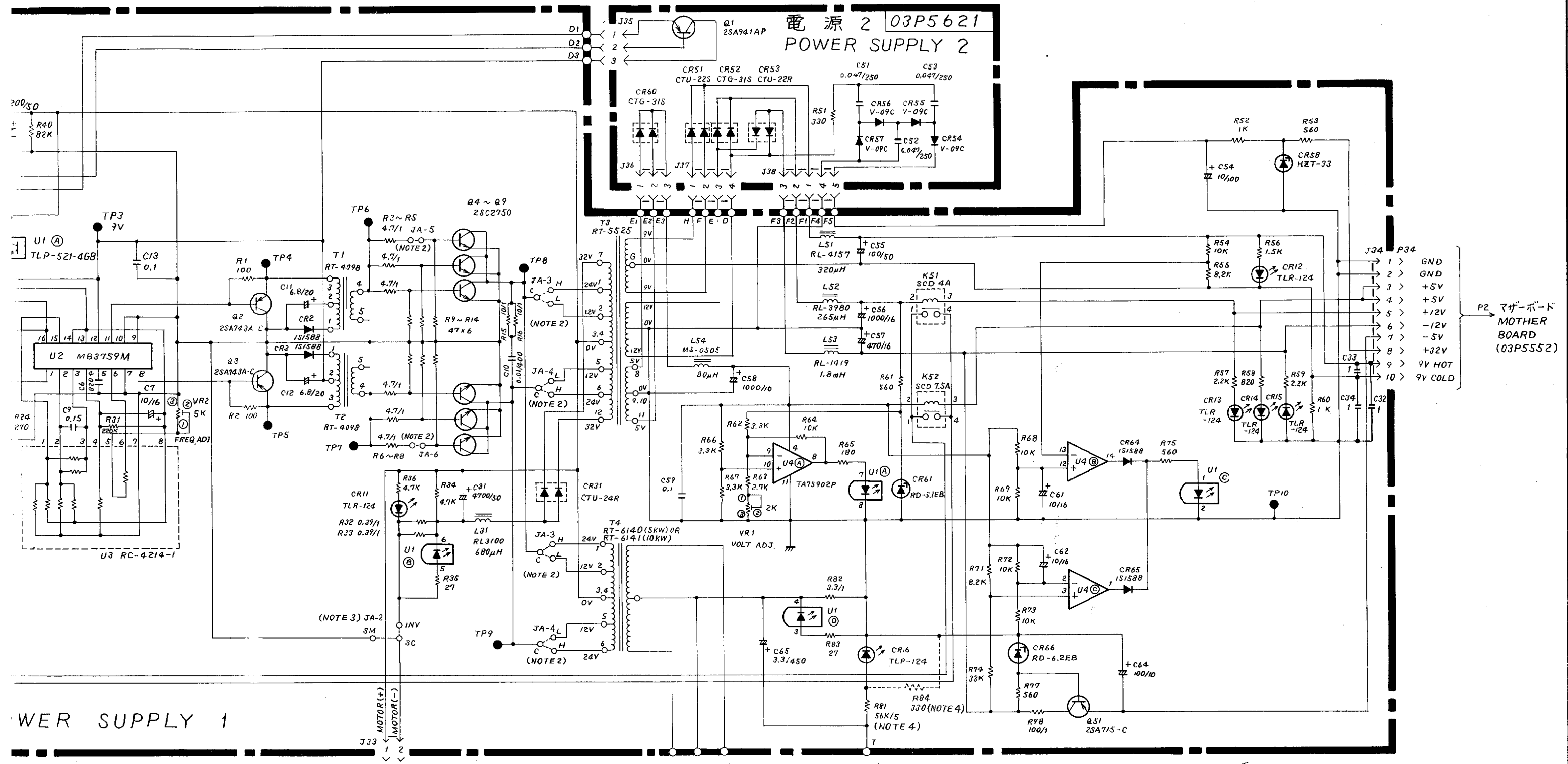

POWER SUPPLY 1

電源 2 03P5621  
POWER SUPPLY 2

P2 マザーボード  
MOTHER BOARD  
(03P5552)

マザーボード  
MOTHER BOARD (03P5552)

送信高压 TX HV

電源 1 PARTS NO 1B2 ---  
POWER SUPPLY 1  
電源 2 PARTS NO. 1B3 ---  
POWER SUPPLY 2

MF.  
MICROFARADS UNLESS NOTED OTHERWISE.

NOTE 3 ; 空中線型式により右の様にジャンパする。  
CHANGE CONNECTION WITH THE  
TYPE OF ANTENNA RADIATOR.

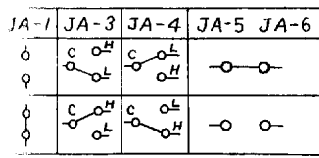

RADIATOR	JA-2	船内電源 SHIP'S MAINS
XN-4A (2.4M)	SM - INV O - SC	24VDC only
その他 OTHERS	SM - INV O - SC	12/24/32VDC

NOTE 4 ; FR-825D(A)では次の様になる。  
IN FR-825D(A), RESISTORS  
ARE AS FOLLOWS.  
R81 : 27K/10W  
R84 : ADDED追加

NOTE 5 :

FR-80S	FR-810	FR-825
03P5620	A03P5620	B03P5620

FR-805D(A)/810D(A)/810DS/825D(A)

承認 APPROVED		名称 TITLE	電源部 POWER SUPPLY
検閲 CHECKED		製図 DRAWN	番番 DWG. NO. C3276-006-H



03P5620  
(NOTE 5)

電源 2 03P5621  
POWER SUPPLY 2

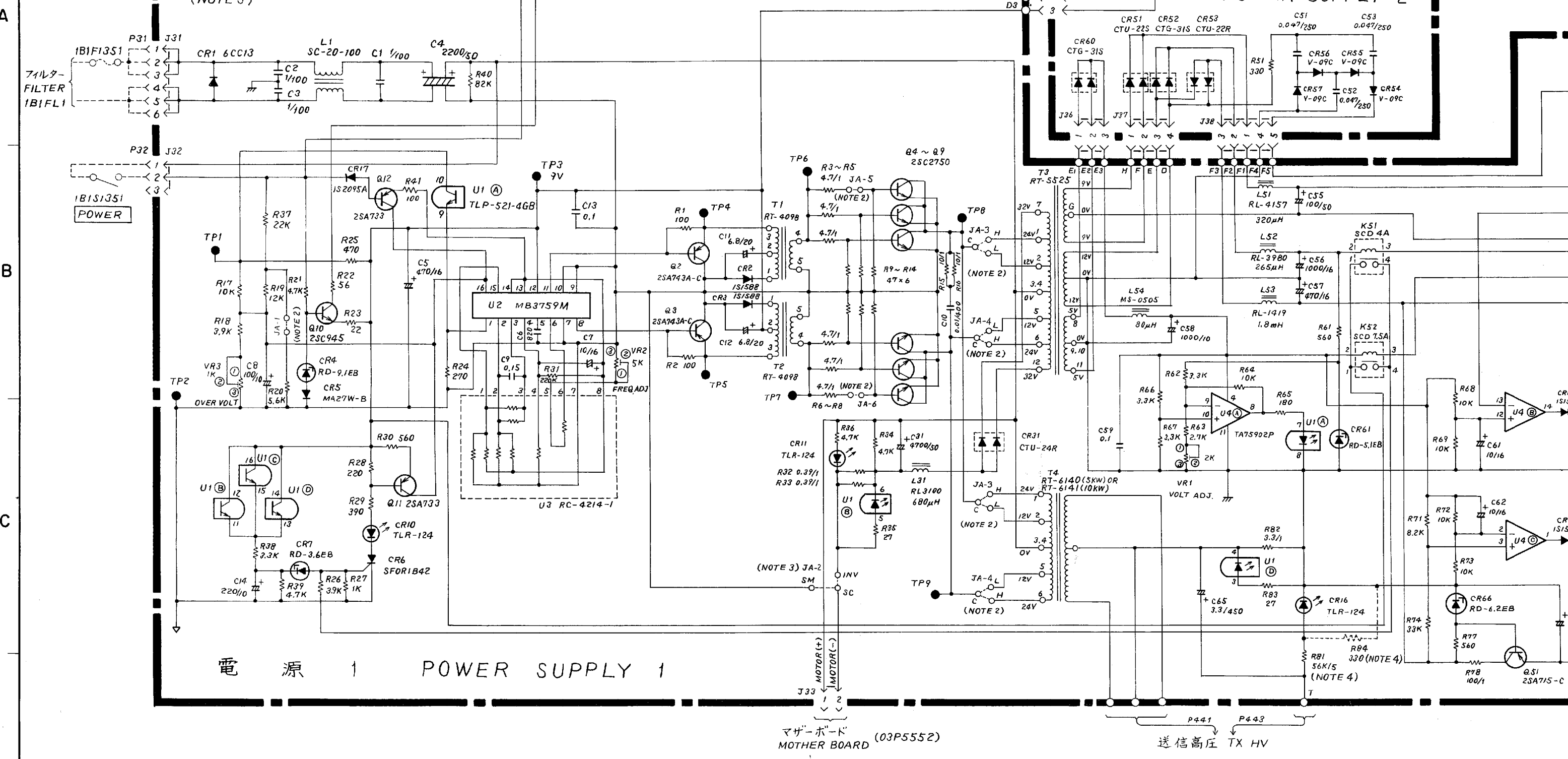

NOTE 1 ; 特記なき抵抗の単位は全てΩ, 0.25W またコンデンサはμF.  
ALL RESISTANCE IN OHMS, 0.25W, CAPACITANCE IN MICROFARADS UNLESS NOTED OTHERWISE.

NOTE 2 ; 電源仕様により右の様にジャンパする。  
CHANGE CONNECTIONS WITH SHIP'S MAINS VOLTAGE.

MAINS VTG.	JA-1	JA-3	JA-4	JA-5	JA-6
10.4~15VDC	○	○	○	○	○
20.4~40VDC	○	○	○	○	○

NOTE 3 ; 空中線型式により右の様にジャンパする。  
CHANGE CONNECTION WITH THE TYPE OF ANTENNA RADIATOR.

RADIATOR	JA-2	船内電源 SHIP'S MAINS
XN-4A (2.4m)	SM ○ INV ○ SC	24VDC only
その他 OTHERS	SM ○ INV ○ SC	12/24/32VDC

NOTE 4 ; FR-825D(A)では次の様になる。  
IN FR-825D(A), RESISTORS ARE AS FOLLOWS.  
R81 : 27K/10W  
R84 : ADDED 追加

NOTE 5 ;

	FR-805	FR-810	FR-825
03P5620	A03P5620	B03P5620	

承認  
APPROVE  
検区  
CHECKE  
製区  
DRAWN

REV

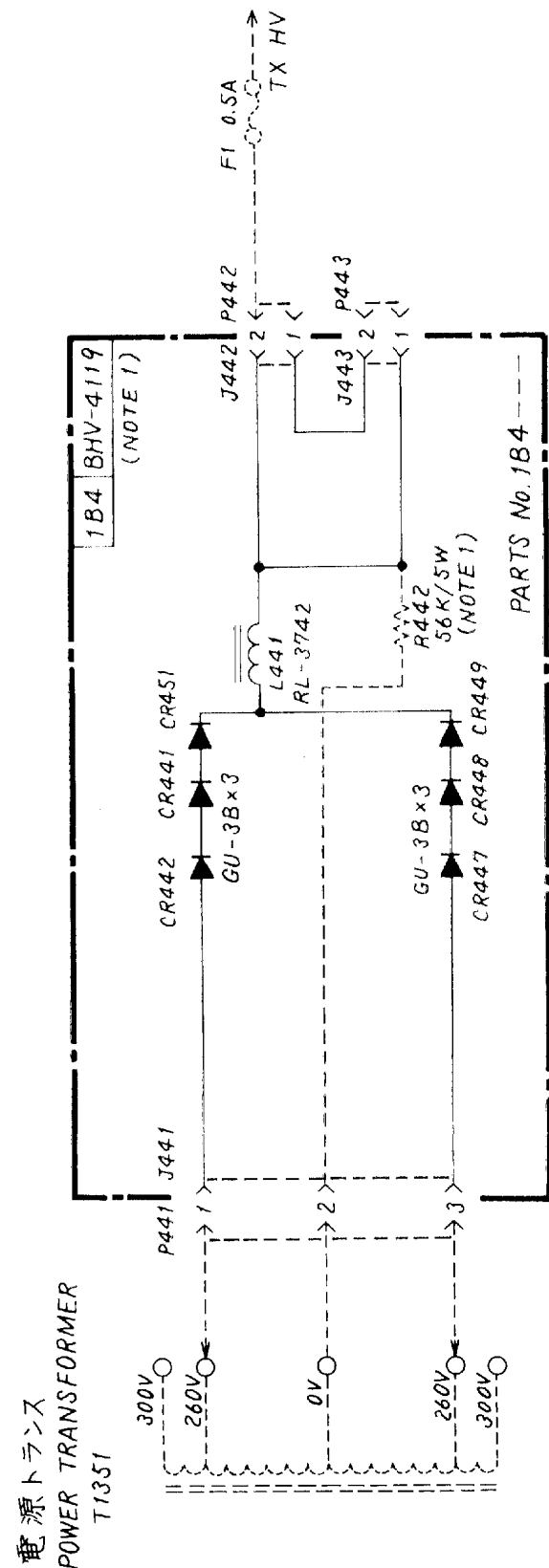

電源トランス  
POWER TRANSFORMER  
T1351

TAP SELECTION タップ変更  
FCR-1401/FR-805D(A): 260V  
FCR-1411/FR-810D(A): 300V

NOTE 1: FR-810D(A)及びFR-810DSでは次の様になる。  
IN FR-810D(A)/810DS, TYPE OF PCB  
& R442 ARE AS FOLLOWS.  
TYPE 型名: DHV-4119  
R442: ADDED 追加

FR-810DS  
FR-805D(A)/810D(A)  
FCR-1401/1411

品番 ITEM	品名 NAME	材質 MATERIAL	数量 QTY	図番 DWG.NO.	摘要 REMARKS
	三角法 THIRD ANGLE PROJECTION				
	尺 SCALE				
	重量 WEIGHT	kg			
	図番 DWG.NO.			C3259-010-D	

REV.: 4/84  
9/86

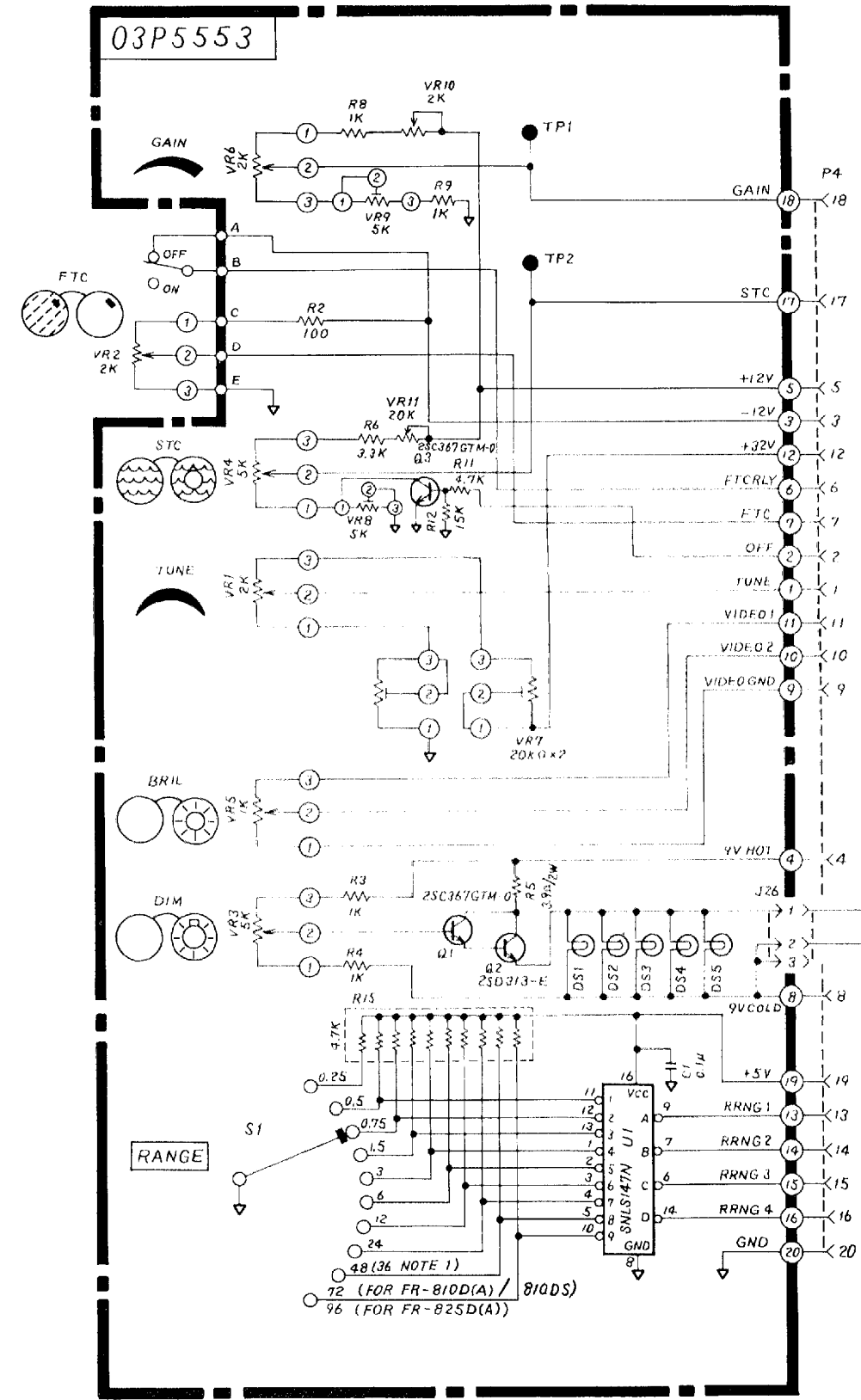

NOTE 1: FR-801D/802D/803Dの場合は36遅。  
36NM FOR FR-801D/802D/803D.

NOTE 2: 前記なき抵抗の単位は全てΩ, 0.25W, πコンデンサはF。  
ALL RESISTANCE IN OHMS, 0.25, AND CAPACITANCE IN FARADS UNLESS NOTED OTHERWISE.

FR-810DS  
FR-825D(A)  
FR-801D/802D  
FR-803D/805D(A)/810D(A)

品番 ITEM	品名 NAME	材質 MATERIAL	数量 QTY	図番 DWG.NO.	摘要 REMARKS
	三角法 THIRD ANGLE PROJECTION				
	尺 SCALE				
	重量 WEIGHT	kg			
	図番 DWG.NO.			C3276-004-F	

REV.: 5/85, 10/85

03P5554

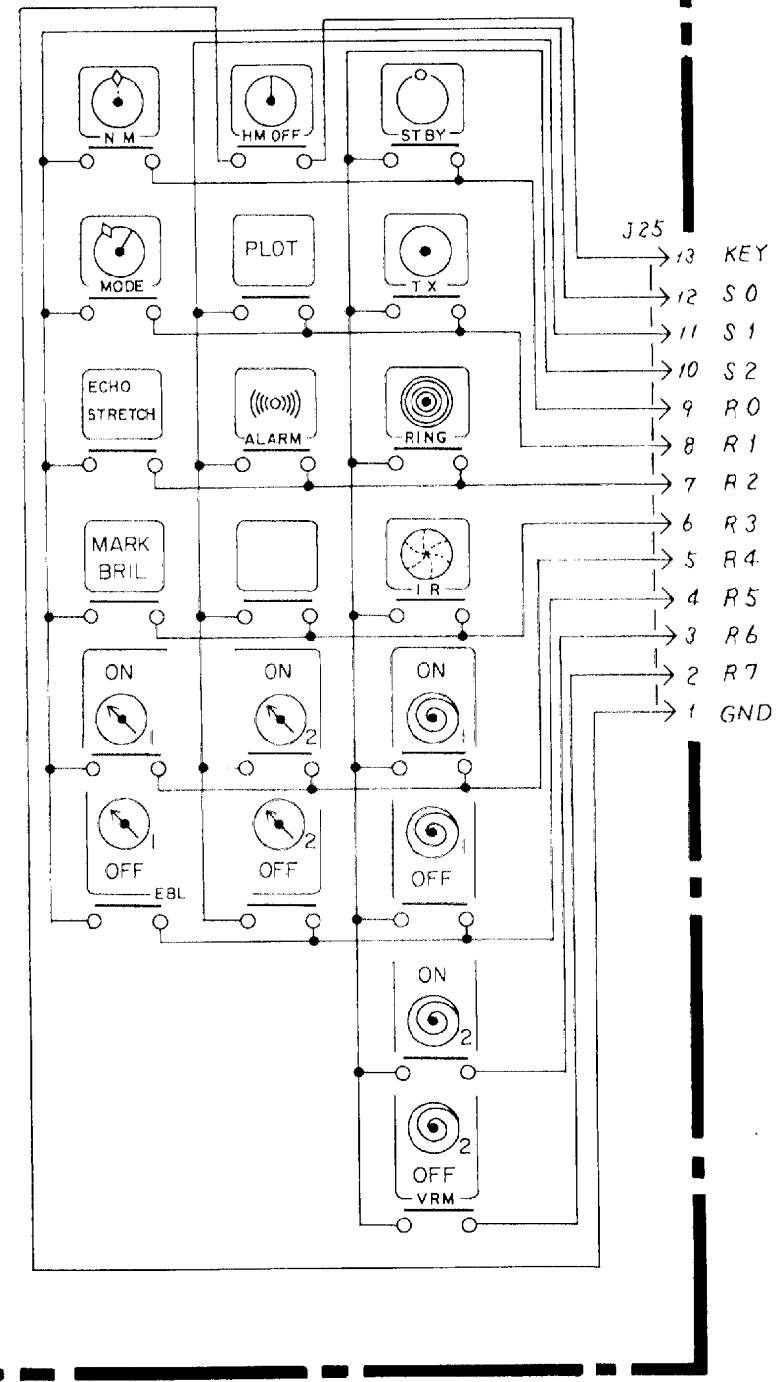

FMD-800  
FR-810DS  
FR-825D(A)  
FR-801D/802D  
FR-803D/805D(A)/810D(A)

FMD-800/FR-810DS/FR-825D(A)/805D(A)/810D(A)の時 PARTS NO. 1B9 ---  
FOR FMD-800/FR-810DS/FR-825DA/805D(A)/810D(A)  
FR-801D/802D/803Dの時 PARTS NO. 1B8 ---  
FOR FR-801D/802D/803D

承認 APPROVED	品番 ITEM	品名 NAME	材質 MATERIAL	数量 Q'TY	図番 DWG. NO.	摘要 REMARKS
DEC. 11 '84		三角法 THIRD ANGLE PROJECTION				
検査 CHECKED		尺度 SCALE				
製造 DRAWN		重量 WEIGHT	kg			
		名称 TITLE		キーボード基板 TOUCHPAD KEY BOARD		
		図番 DWG. NO.		C3276-003-E		

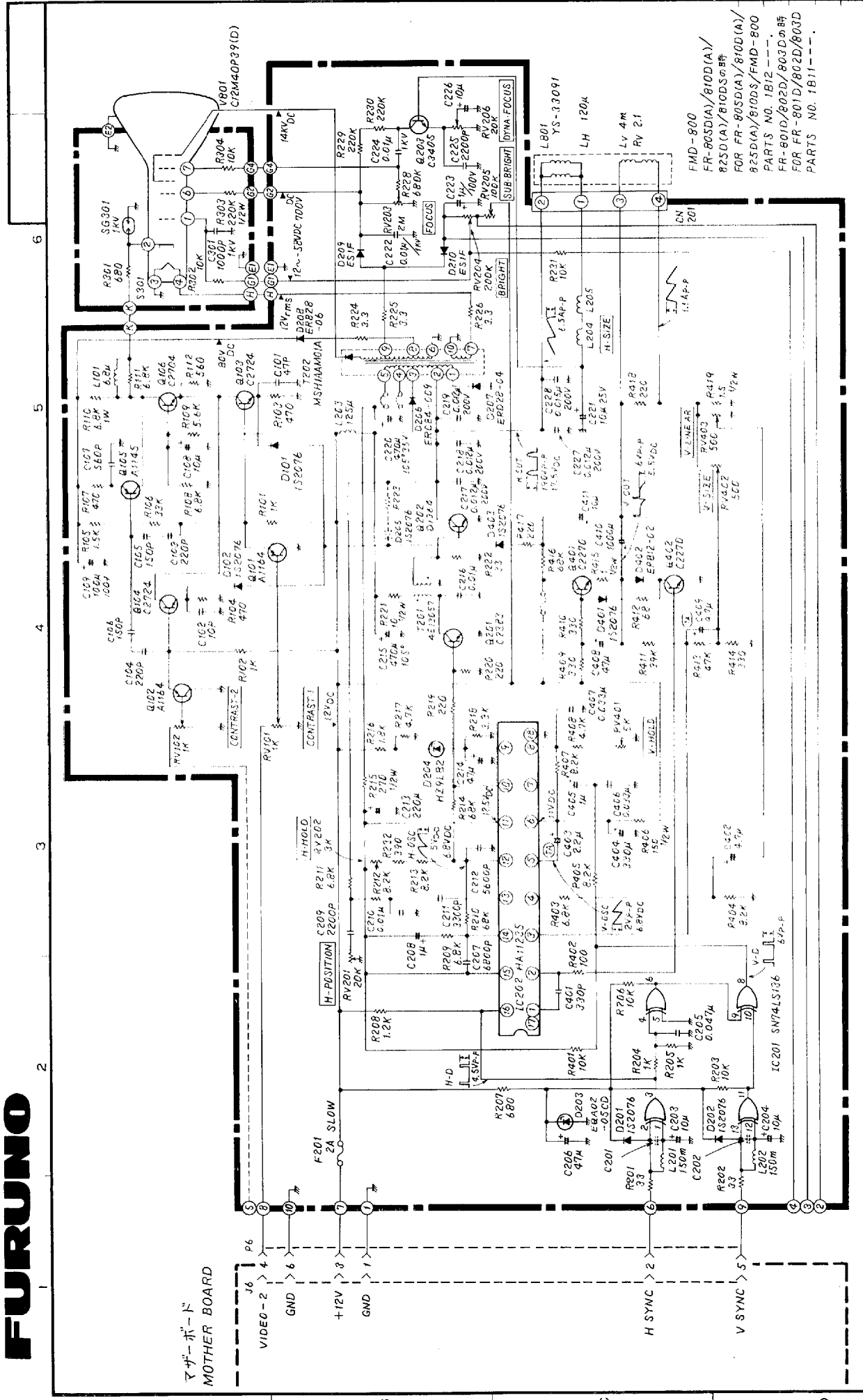

承認 APPROVED	品番 ITEM	品名 NAME	数量 Q'TY	図番 DWG. NO.	摘要 REMARKS
DEC. 17 '84		表示部 CRT DISPLAY (MG-1250SFR)			
検査 CHECKED		尺度 SCALE			
製造 DRAWN		重量 WEIGHT			
		図番 DWG. NO.		C3276-008-G	

FMD-800  
FR-810DS  
FR-801D  
FR-802D  
FR-803D  
FR-805D(A)  
FR-825D(A)

NOTE 1: 特記なき抵抗の単位は全て、0.25W x コンデンサは、p.F.  
ALL RESISTANCE IN OHMS, 0.25W, CAPACITANCE  
IN FARADS UNLESS NOTED OTHERWISE.

**FURUNO**

03P6571

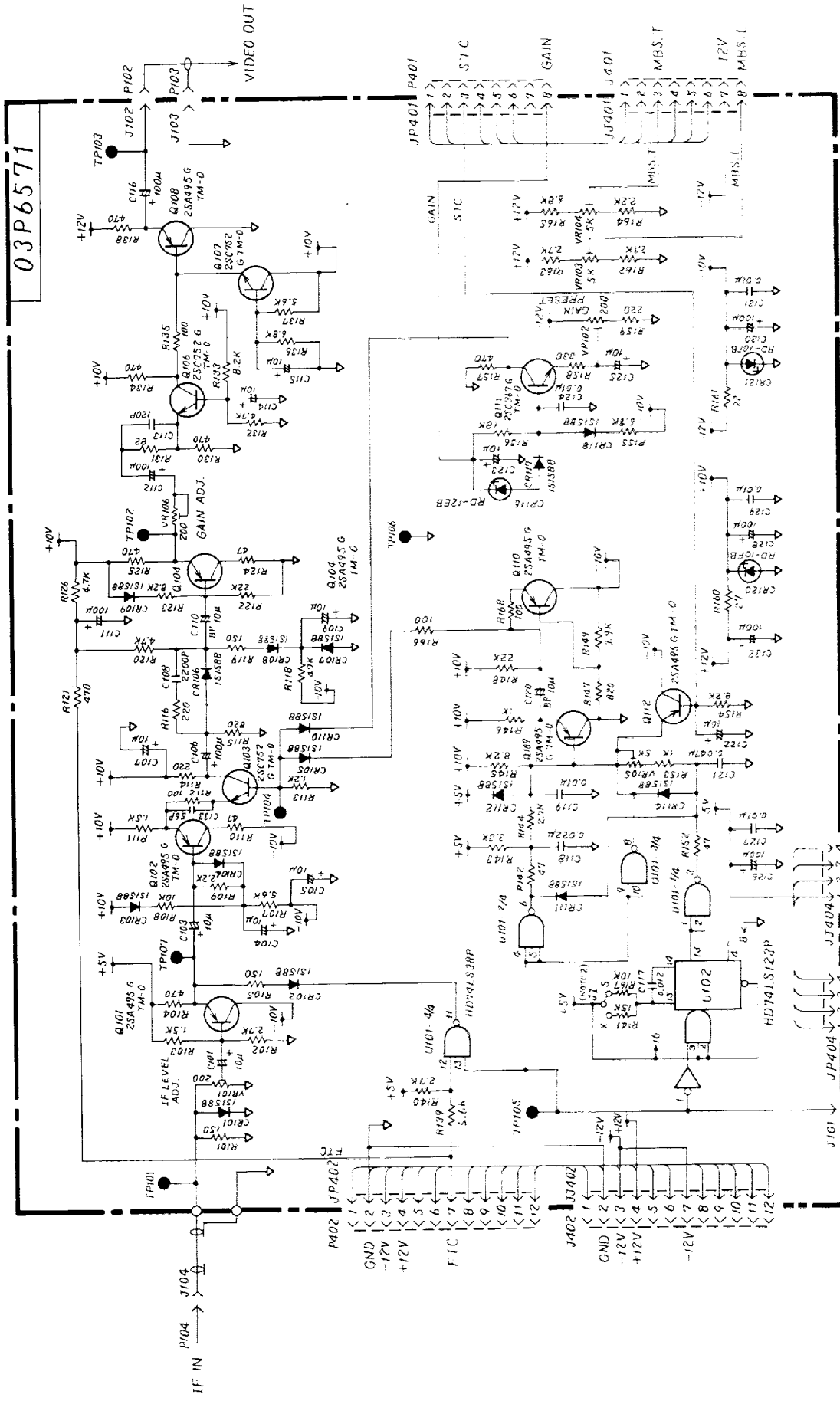

品名	品名	材料	数量	材料	数量	材料	数量	材料	数量
ITEM	NAME	MATERIAL	QTY	MATERIAL	QTY	MATERIAL	QTY	MATERIAL	QTY
03P6571 GSC 基板 THIRD ANGLE PROJECTION SCALE WEIGHT APPROVED CHECKED DRAWN									
TITLE 03P6571 GSC BOARD DWG. NO. C3291-014-B DATE MAY. 15 '86 MAY. 14 '86									
備註 IR 変 REMARKS									

NOTE 1 ; 特記なき抵抗の単位は全てΩ、0.25W X 3/16インチは F、  
 ALL RESISTANCE IN OHMS, 0.25W, CAPACITANCE IN FARADS UNLESS NOTED OTHERWISE.

NOTE 2 ; J1 は S-BAND レーダーに、J2 は X-BAND レーダーに、J3 は X-BAND レーダーに、J4 は X-BAND レーダーに、  
 J1 SHOULD BE CONNECTED TO "S" FOR S-BAND RADARS, AND "X" FOR X-BAND RADARS.

I.R. BIODS, FMD-800(LOG)

FURUNO ELECTRIC CO., LTD.

## APPENDIX 1 INSTALLATION INSTRUCTIONS

## 1.1 General

This radar system is mainly composed of two units; the display unit and the scanner unit, and operates directly from 24V d.c. ship's mains. For operation from 100V, 110V, 115V or 220V a.c., the rectifier unit (RU-1746B-2) is additionally used. When the radar is unpacked, check that all necessary units, parts and materials are contained referring to the equipment list, the installation materials list and the spare parts list. The steel and wood works should be arranged locally.

## 1.2 Siting of the Units

Scanner Unit

The unit is normally installed on the wheelhouse top with a hardwood pad shaped to meet vessel's deck chamber, or on a radar mast with an appropriate platform. When siting the unit, consideration must be given on the following points.

- 1) The interconnecting cable type RW-4873 between the scanner unit and the display unit is supplied 15m long. (Additional interconnect cable for longer runs is available up to a maximum of 30m. Consult with Furuno dealer.)
- 2) A funnel, mast or derrick post in line of sight of the radiator may cause blind sectors on the radar picture. The blind sector between 355 degs and 5 degs must be avoided by carefully planning the installation site.
- 3) Deposits and fumes from the funnel or other exhaust vent can adversely affect the aerial performance and hot gas tends to distort the radiator portion. The scanner unit must not be mounted in a position where it is subjected to temperature in excess of 70°C.
- 4) The compass safe distance, 2.5m standard compass and 1.9m steering compass, should be observed.
- 5) The unit must not be positioned in close proximity to a direction finder (DF) aerial; separation of more than 2m is required.
- 6) Sufficient clearance should be allowed around the unit for checking and service. See page AP1-6.

Display Unit

Choose a location to mount the unit that allows:

- \* Accessibility to front panel controls.
- \* Connection to a power source and the scanner unit. (15m cable supplied)
- \* Compass safe distance of 1.3m standard and 0.75m steering.
- \* Protection from sea spray, rain and temperature in excess of 50°C.
- \* Convenience for observing picture on the screen. The direct path of bright sunshine or overhead lighting will disturb observation.

## 1.3 Scanner Unit Installation

The antenna radiator and the scanner housing are shipped in separate packages and must be assembled at installation. Use the following procedure for mounting the scanner unit.

CAUTIONS:

- 1) Follow the safety rule and use safety devices for dangerous work on the radar mast.
- 2) The scanner base is made of aluminium cast. To prevent the scanner base from electrolytic corrosion, use the seal washers and corrosion-proof rubber mat and ground the unit with the grounding wire, supplied as the installation materials. Refer to page AP1-5.
- 3) Be sure to apply the adhesive (Non-acid type silicone sealant) supplied as the installation materials to bolts, nuts and washers. Do not use other type of sealant which may contain acetic acid.
- 4) Do not paint the radiator aperture.
- 5) Do not lift the scanner unit holding the radiator. (Use lifting hooks.)
- 6) When assembling the antenna radiator, apply the adhesive (coat of waterproof compound) between mating surfaces of rotary joint flange. Do not apply it into the groove for O-ring!

Scanner Unit Assembling

It is recommended to install the antenna radiator on the scanner base before mounting the scanner unit on the radar mast. Refer to the scanner unit assembling on page AP1-7.

- 1) Remove two protection caps from the radiator flange and rotary joint flange.
- 2) Place the O-ring in the groove of the rotary joint flange. Make sure the O-ring is fully greased. Make very sure the O-ring is not pinched during assembling!
- 3) Secure the feeder waveguide on the rotary joint flange with four M6x16 hex. bolts.
- 4) Fix the feeder waveguide on the radiator bracket with a waveguide clamp, a clamp insulator, two flat washers and two M6x50 hex. bolts.
- 5) Place the greased O-ring in the groove of the radiator flange.
- 6) Put the antenna radiator on the bracket and fix it temporarily with eight M10x20 hex. bolts, spring washers and flat washers.
- 7) Secure the feeder waveguide to the radiator flange with four M6x16 hex. bolts.
- 8) Tighten the antenna radiator on the bracket with eight M10x20 bolts.

NOTE: Apply the silicone sealant on the fixing bolts, washers and waveguide flanges outside the O-ring groove, beforehand for anti-corrosion. Do not apply sealant to the O-ring and O-ring groove. (Use only non-acid type of silicone sealant supplied. Acetic acid contained in other types of sealants will cause damage!)

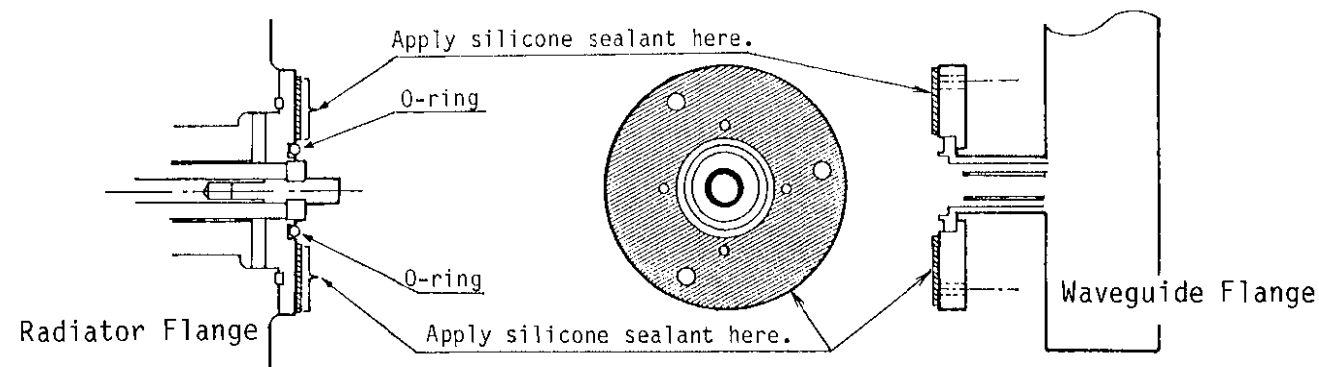
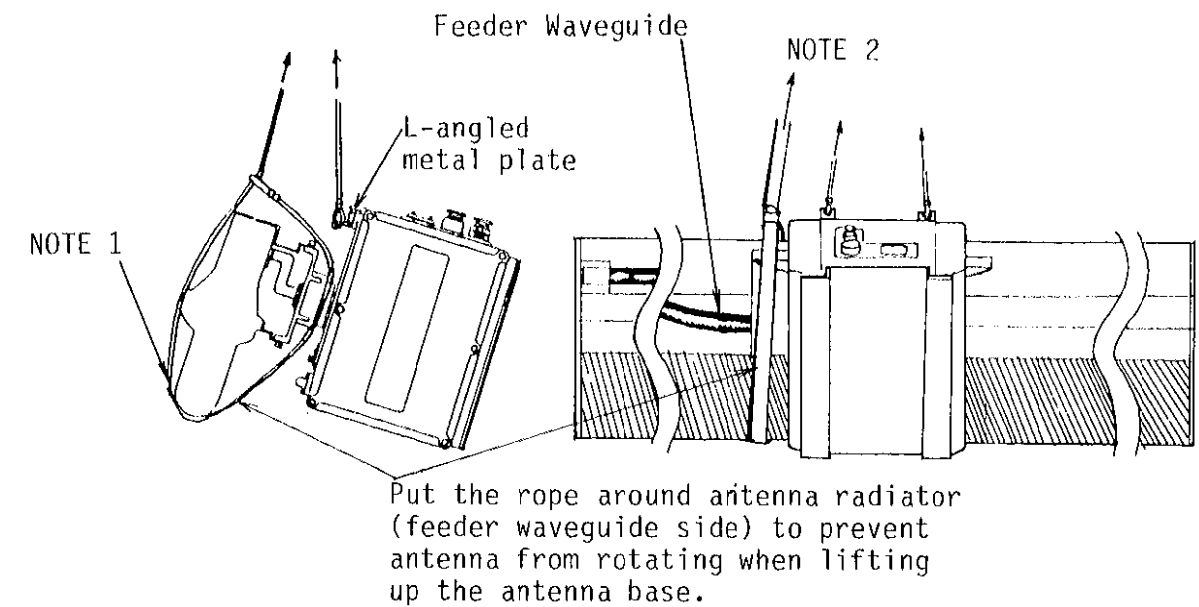

Fig.1

How to Mount Scanner Unit

- 1) Drill four bolt holes (15mm dia.) in the radar mast platform or the deck, referring to the scanner outline drawing on page AP1-6.
- 2) Place the corrosion-proof rubber mats supplied as the installation materials on the mounting platform where the scanner base will be positioned. This is to prevent the scanner base made of aluminum cast from the electrolytic corrosion. See the next page.
- 3) Using two L-angled metal plates on the scanner top, lift the scanner base with the antenna radiator and place the scanner unit on the rubber mats so that the cable glands face the ship's stern.



- NOTE 1. Take care not to damage antenna surface by the rope.  
 2. Tensile load should not be applied to antenna radiator.

Fig.2

- 4) Fix the scanner base to the mounting platform by using four M12x60 hex. bolts, nuts, washers and seal washers supplied as the installation materials. See the next page.
- 5) Arrange the grounding terminal at the nearest grounding spot using a M6x25 hex. bolt, a nut and washers supplied as the installation materials. Then fix a grounding wire (RW-4747, 320mm long) to the terminal. See the next page.
- 6) Connect the other end of the grounding wire to the grounding terminal of the scanner unit.
- 7) Apply silicone sealant supplied as the installation materials to the grounding terminal and the fixing bolts.

REMARKS ON INSTALLATION OF SCANNER UNIT

The scanner base is made of aluminum cast. To prevent the scanner base from electrolytic corrosion, place the seal washer and corrosion-proof rubber, and run the grounding wire between the grounding terminal fitted on the scanner body and the nearest grounding spot as illustrated below. (These parts are supplied as the installation materials.)

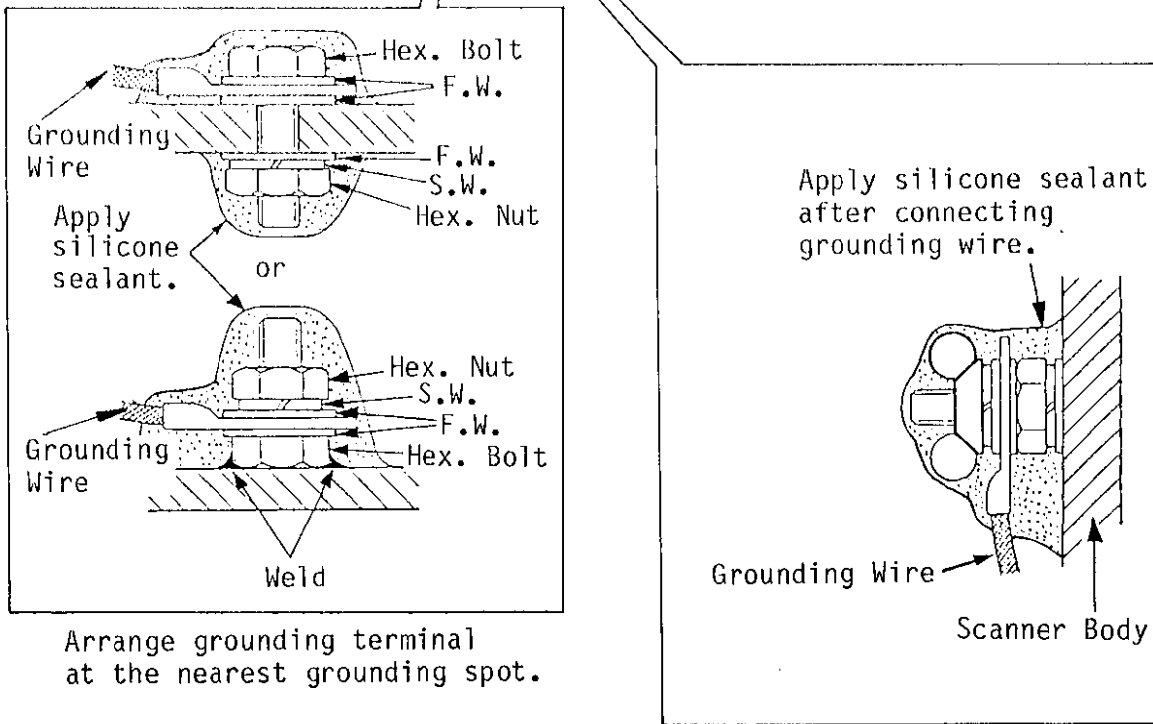
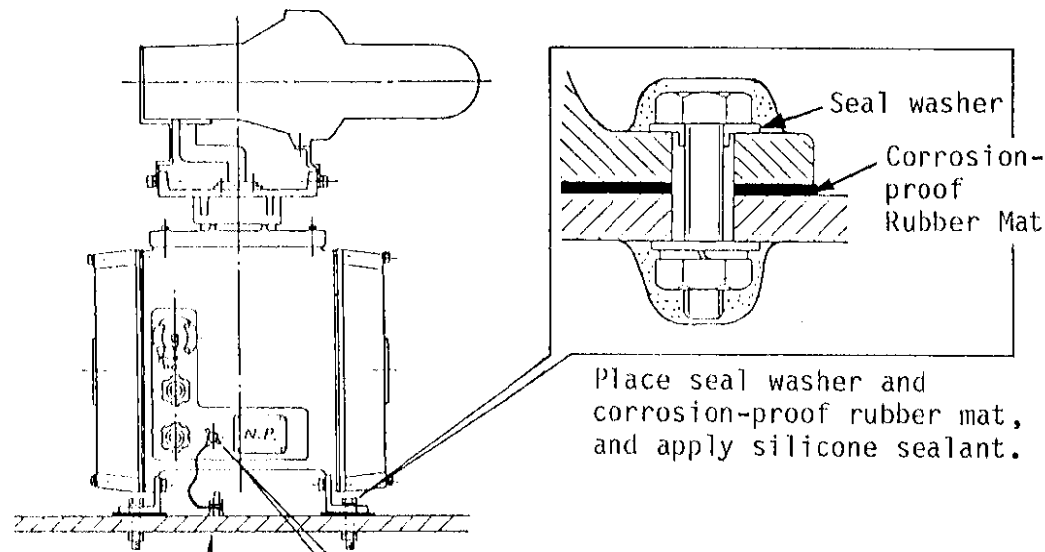

Arrange grounding terminal at the nearest grounding spot.

Grounding terminal is factory-fitted on the scanner body.

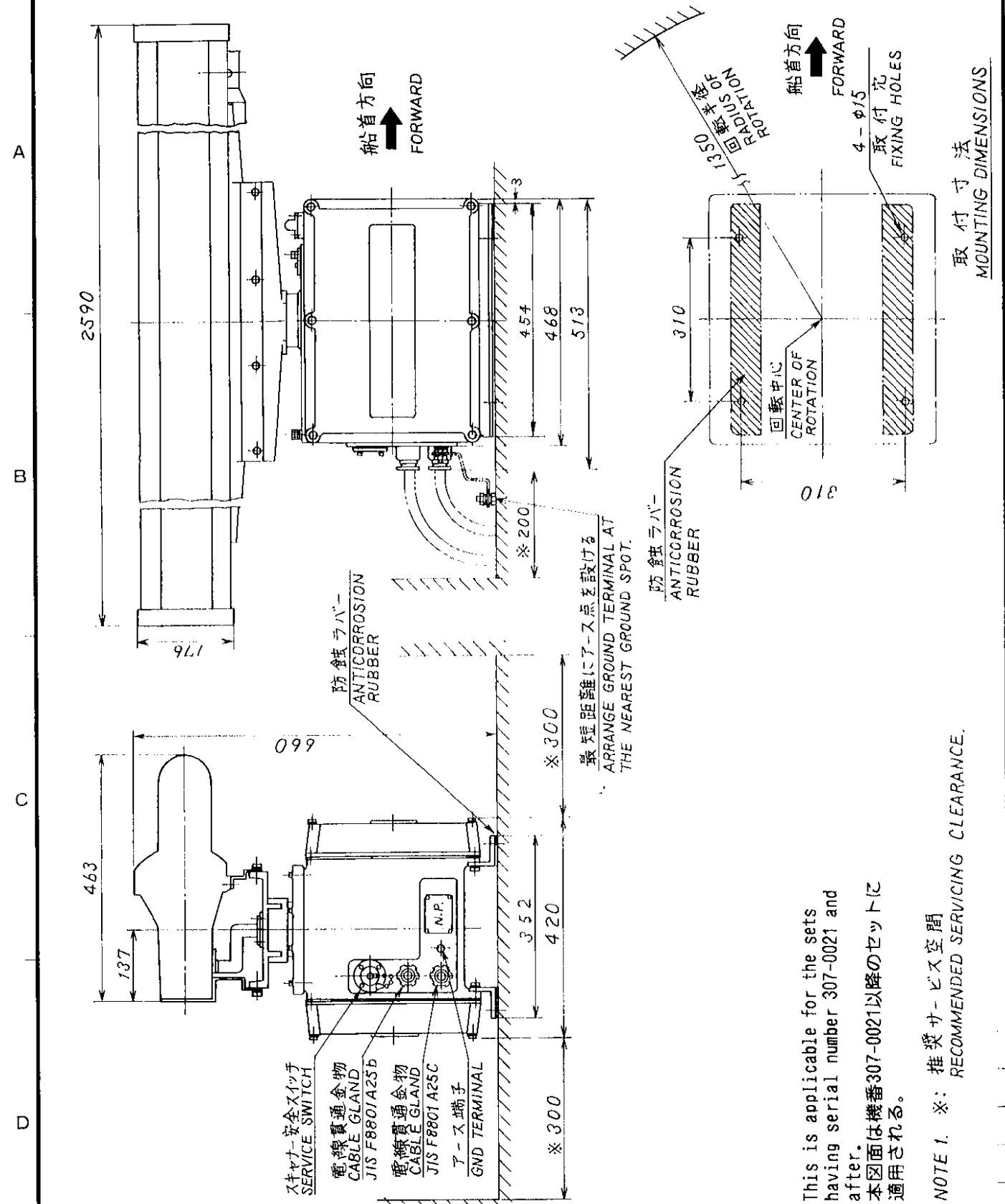

This is applicable for the sets having serial number 307-0021 and after.  
本図面は機番307-0021以降のセットに適用される。

NOTE 1. ※: 推奨サービス空間 RECOMMENDED SERVICING CLEARANCE.

FR-810 DS	品番 ITEM	品名 NAME	材質 MATERIAL	数量 Q'TY	図番 DWG.NO.	備考 REMARKS
承認 APPROVED	MBR. 19. '86	三角法 THIRD ANGLE PROJECTION				名称 TITLE レーダー空中線部外觀図 RADAR SCANNER UNIT
検図 CHECKED	Mar. 19. '86	尺度 SCALE 1/10				
製図 DRAWN	MAR. 19. '86	重量 WEIGHT 75 kg			図番 DWG.NO. C3291-004-B	

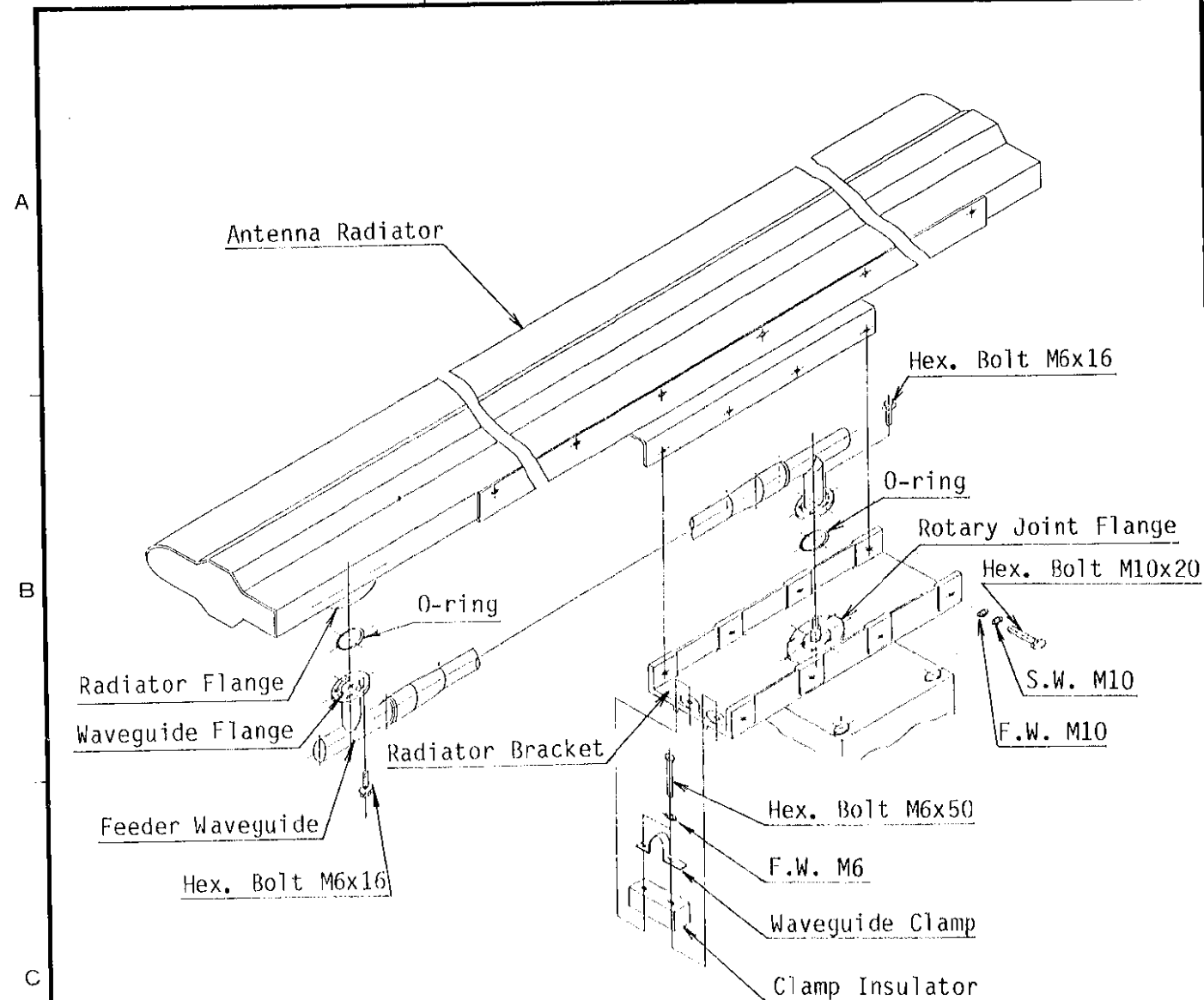

- NOTE 1. Apply silicone sealant (supplied, non-acid type) on bolts, nuts, washers and waveguide flanges outside O-ring grooves to avoid electrolytic corrosion. (Do not apply sealant to O-rings and O-ring grooves.)
2. Do not pinch O-ring and keep it clean.
3. For packings of scanner covers and O-rings, do not use silicone sealant, but rather use grease.

品番 ITEM	品名 NAME	材質 MATERIAL	数量 Q'TY	図番 DWG. NO.	摘要 REMARKS
承認 APPROVED	三角法 THIRD ANGLE PROJECTION	名称 TITLE Scanner Unit Assembling			
検 CHECKED	尺 SCALE				
製 DRAWN	重 WEIGHT	kg	図番 DWG. NO.		

1.4 Display Unit Installation

As supplied, the display unit is provided for tabletop mounting, but it can be easily converted for bulkhead/overhead mounting. See page AP1-9.

Mount the display unit as follows:

- 1) Remove the mounting cradle from the display main body by undoing two bolts at the front bottom of the display unit. See Fig.3.
- 2) Drill four bolt holes of 12mm dia. through the tabletop to correspond to the fixing holes on the mounting cradle. See Fig.3 and outline drawing on page AP1-11.
- 3) Secure the mounting cradle on the table by using M10 bolts, nuts and washers or coach screws and washers.
- 4) Place the display main body on the mounting cradle and secure it with the two bolts at the front bottom.

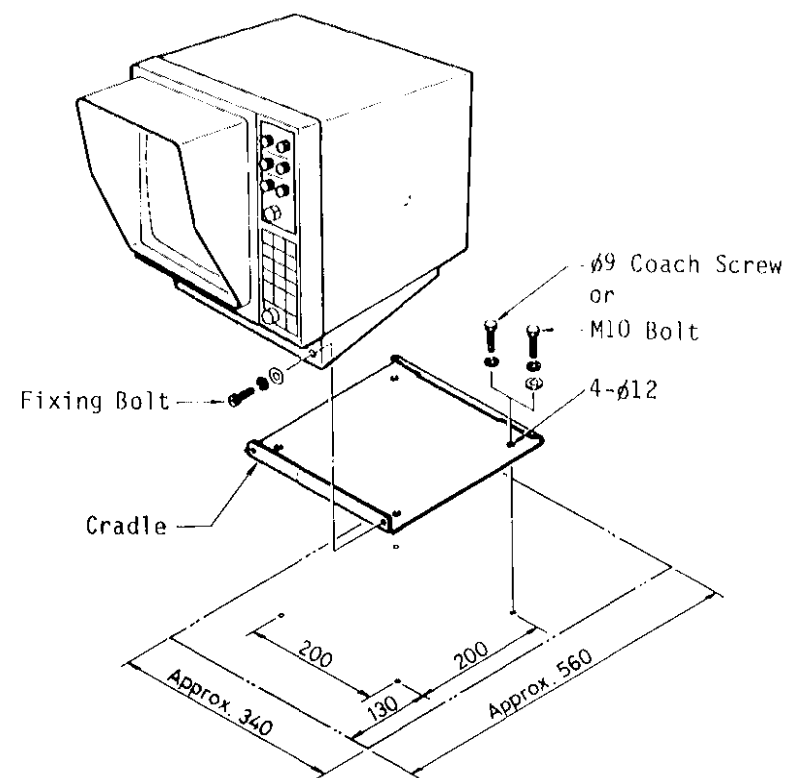

Fig.3 Display Unit Mounting



Conversion from Tabletop Mount to Bulkhead/Overhead Mount

The tabletop mount type display can be converted to the bulkhead or overhead mount type by the following method.

- 1) Take off the top cover (1) by loosening eight M4 x 10 screws (2). See Fig.4.
- 2) Remove the fixing plate (3) with the GSC board by disconnecting the connector plugs mated with the board and loosening four M4 x 8 washerhead screws (4). Then, turn the GSC board 180 degrees horizontally so that a flying connector plug P104 for the video signal is positioned at the place shown in Fig.4.
- 3) Loosen two M8 x 40 hex. bolts (6) and remove the mounting cradle (7) from the ramp base (8).
- 4) Take off the ramp base (8) from the display main body (5) after removing seven M6 x 16 hex. bolts (9) and disconnecting three plugs (11) from the HV board (10) located on the ramp base and three flying connectors (12, 14 and 15).
- 5) Loosen four M3 x 8 washerhead screws securing the HV board (10) to the ramp base (8) and move the HV board from the left to the right as shown below. Then, refix it with the screws.

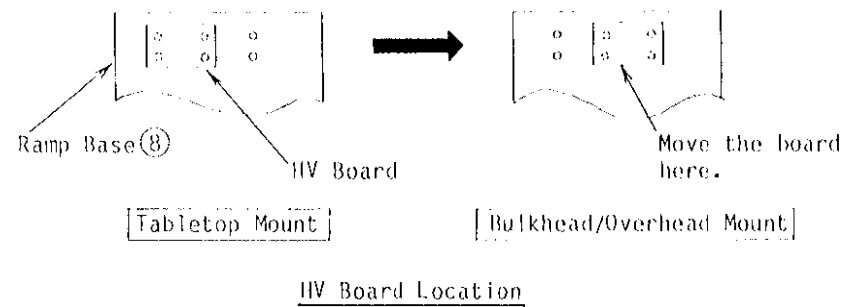

- 6) Loosen the lock nuts of the toggle switches (13) (POWER & SCANNER) on the ramp base (8) and turn them upside down, and secure the lock nuts.
- 7) Attach the label (supplied in the spare parts box) showing the name of the switches.
- 8) Connect three plugs (11) and flying connectors (12, 14 and 15) disconnected in step 4. Then, secure the ramp base (8) on the top of the display main body (5) with seven hex. bolts (9). See Fig.5.
- 9) Secure the fixing plate (3) with four washerhead screws (4) at the place shown in Fig.5 and mate the connector plugs disconnected in step 2 with the GSC board.
- 10) Fit the top cover (1) on the bottom of the display main body (5) and secure it with eight screws (2). To install the unit, secure the mounting cradle (7) on the bulkhead or ceiling before assembling it with the ramp base (8).

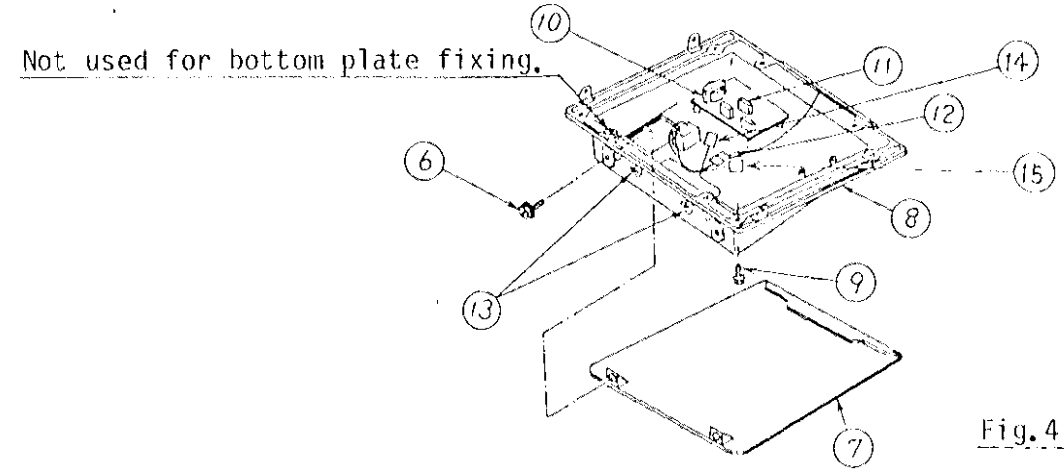
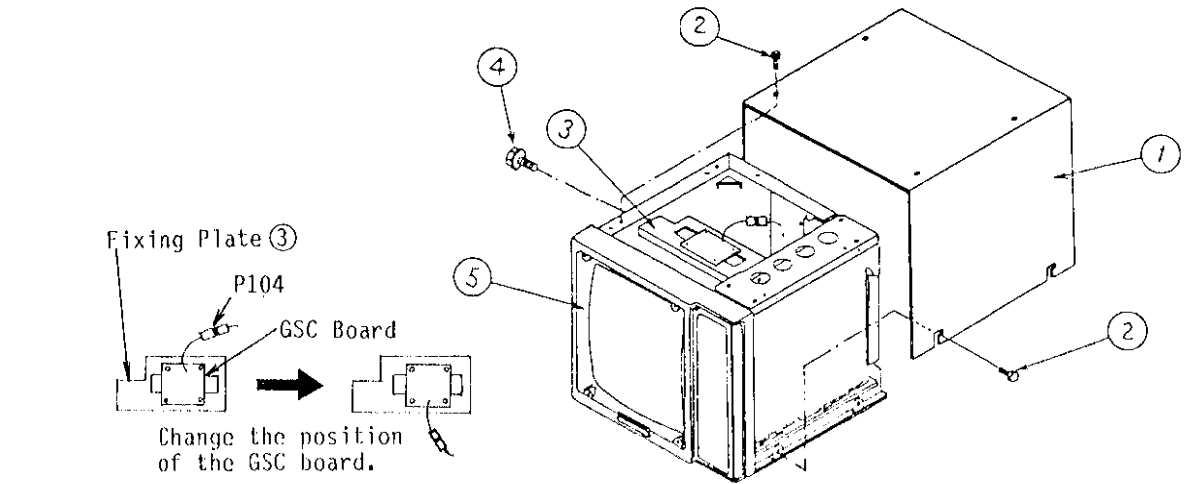

Fig.4 Tabletop Mount

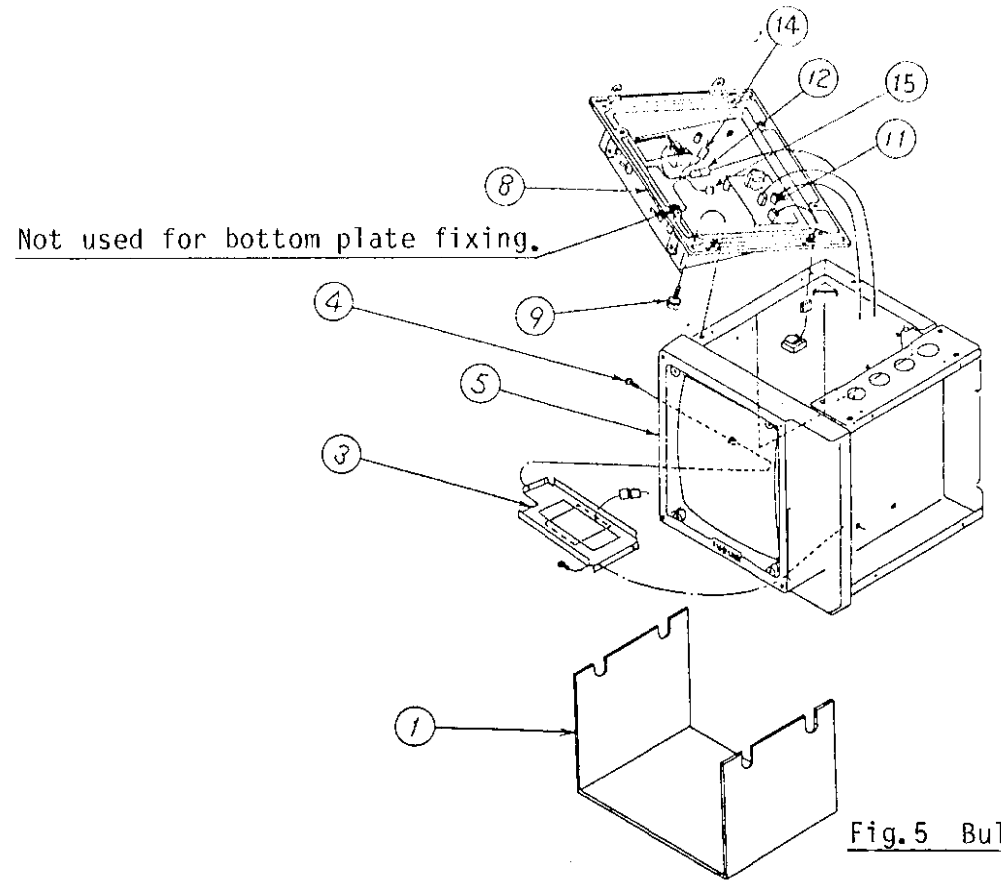
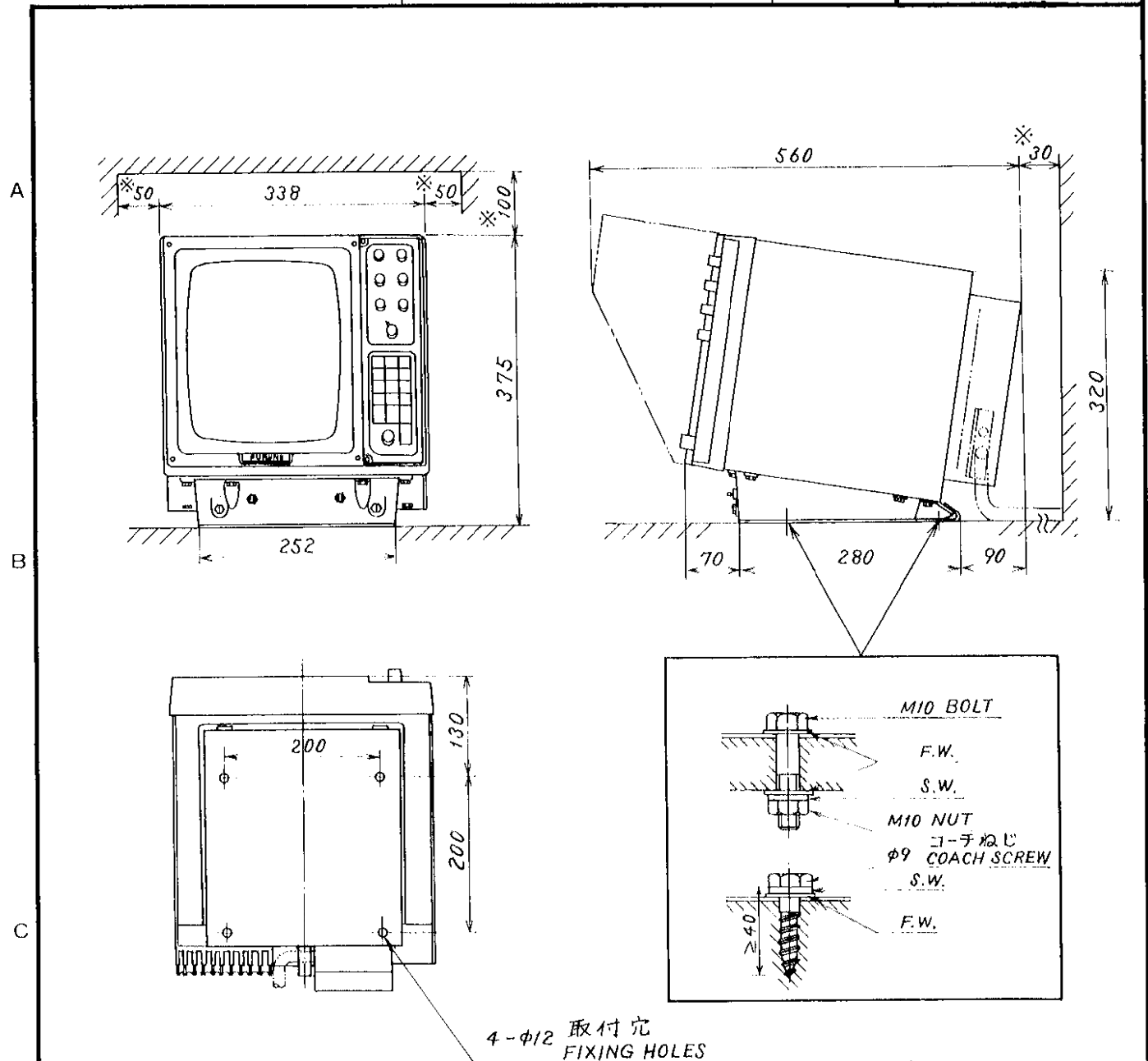

Fig.5 Bulkhead/Overhead Mount



4-φ12 取付穴  
FIXING HOLES

NOTE 1. ※ : 推奨サービス空間。  
RECOMMENDED SERVICING CLEARANCE.

NOTE 2. 装備ケーブルはサービス時、指示部を前方に十分引き出せるよう余裕をもたせること。  
SUFFICIENT EXTRA CABLING SHOULD BE ALLOWED AT THE BACK OF THE UNIT SO THAT THE UNIT CAN BE DRAWN OUT WITH THE CABLES CONNECTED FOR MAINTENANCE.

FR-810DS  
FR-825D(A)  
FR-801D/802D/803D  
FR-805D/810D

承認 APPROVED	品番 ITEM	品名 NAME	材質 MATERIAL	数量 Q'TY	図番 DWG. NO.	摘要 REMARKS
Aug. 13. 84 K. H. H.		三角法 THIRD ANGLE PROJECTION				レーダー指示部寸法図 RADAR DISPLAY UNIT
Aug. 13. 84 K. H. H.		尺度 SCALE		1/8		
Aug. 13. 84 K. H. H.		重量 WEIGHT		20 kg	図番 DWG. NO.	C3276-001-E

REV. : 7/85

1.5 Rectifier Unit Installation (Option)

For the set driven by 100/110/115/220V AC ship's mains, a rectifier unit (RU-1746B-2) is required. The unit can be mounted in any dry, well ventilated place. The mounting dimensions are shown in the rectifier outline drawing on page AP1-13. The compass safe distance of 2.1m standard and 1.5m steering should be observed.

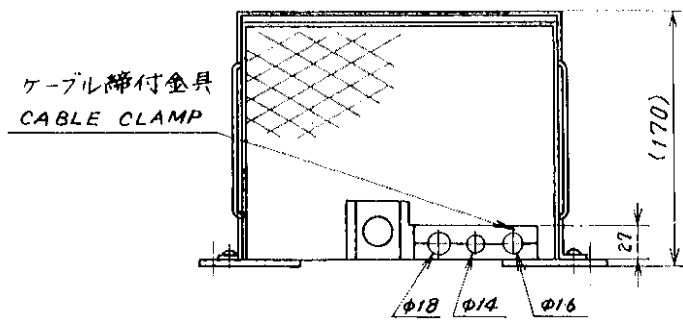
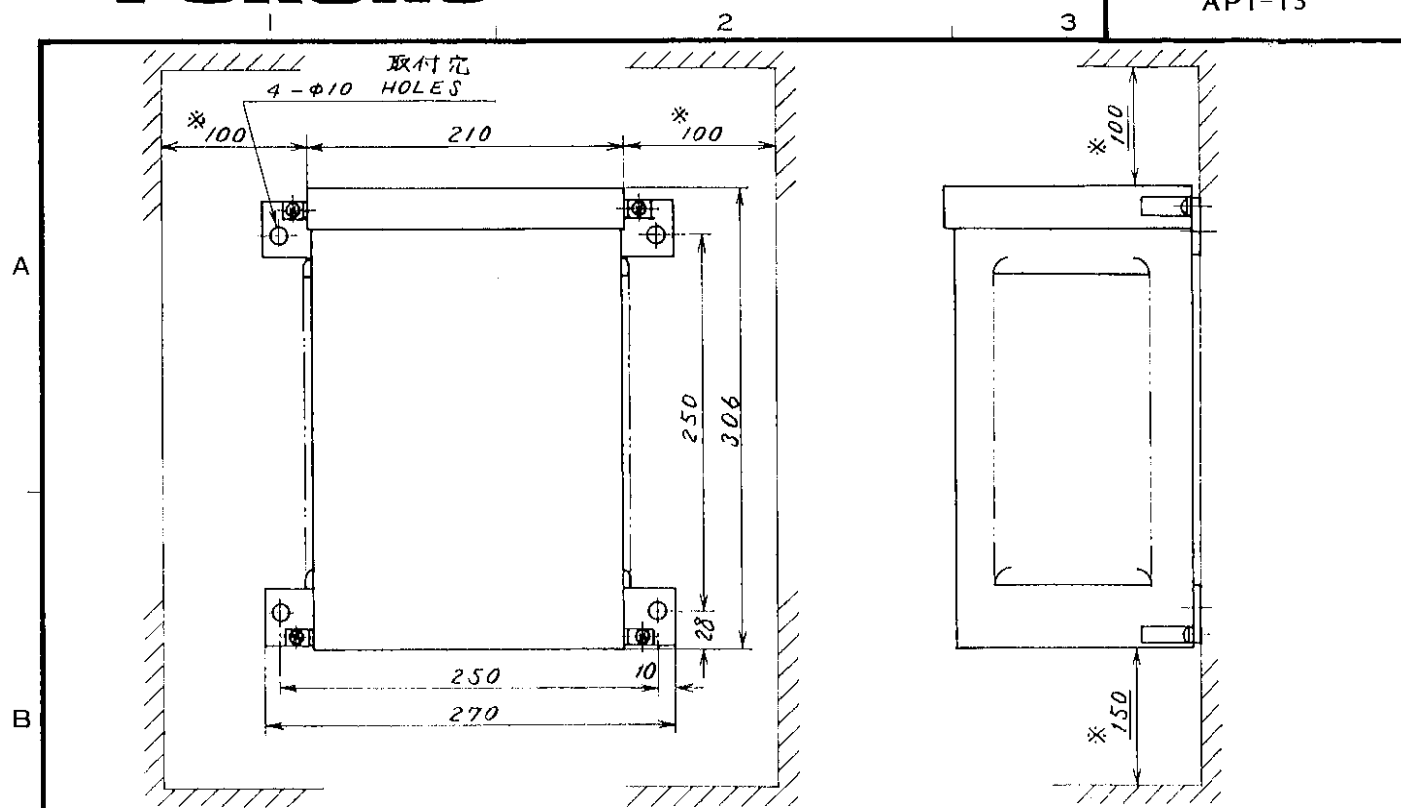

NOTE 1. ※: 推奨サービス空間  
RECOMMENDED SERVICING CLEARANCE.  
2. コンパス安全距離  
COMPASS SAFE DISTANCE.

スタンダード STANDARD	2.1M
ステアリング STEERING	1.5M

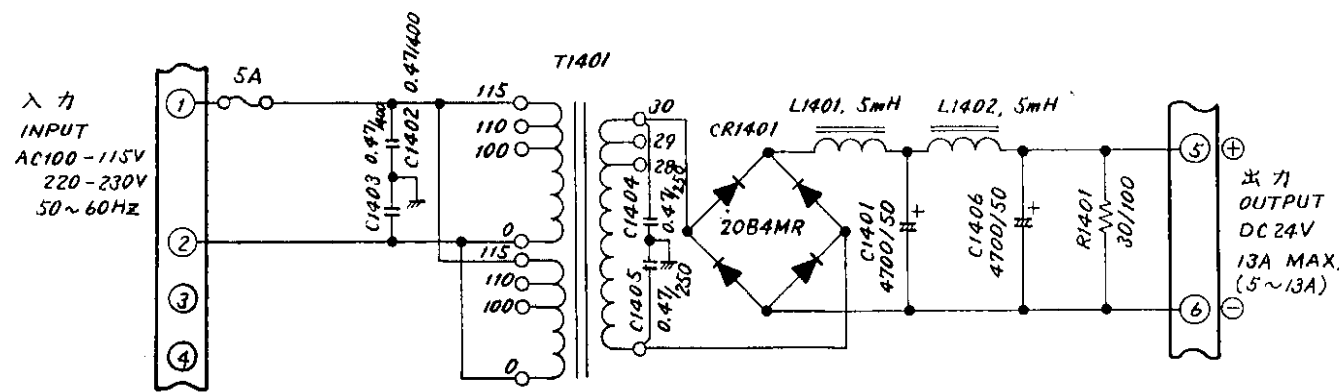

注 AC220V入力に対しては T1401 の一次巻線を直列に接続する。  
NOTE FOR 220VAC INPUT, CONNECT T1401 PRIMARY WINDINGS IN SERIES.

品番 ITEM	品名 NAME	材質 MATERIAL	数量 Q'TY	図番 DWG.NO.	摘要 REMARKS
承認 APPROVED	三角法 THIRD ANGLE PROJECTION	名称 TITLE			
検査 CHECKED	尺度 SCALE	RU-1746B-2 整流器 RECTIFIER UNIT			
製図 DRAWN	重量 WEIGHT	重量 17 kg	図番 DWG.NO.	C3002-002-J	

1.6 Connections

Connections to Display Unit

Two cables run to the display unit. These are;

- a. the multicore cable from the scanner unit.
- b. the power cable from the ship's mains or the rectifier.

The multicore cable is terminated with connectors at one end and ready for connection to the display unit.

The procedure for connecting the cables to the display unit is as follows.

1) Fabricate the power cable as below.

FABRICATION OF POWER CABLE (DISPLAY SIDE)

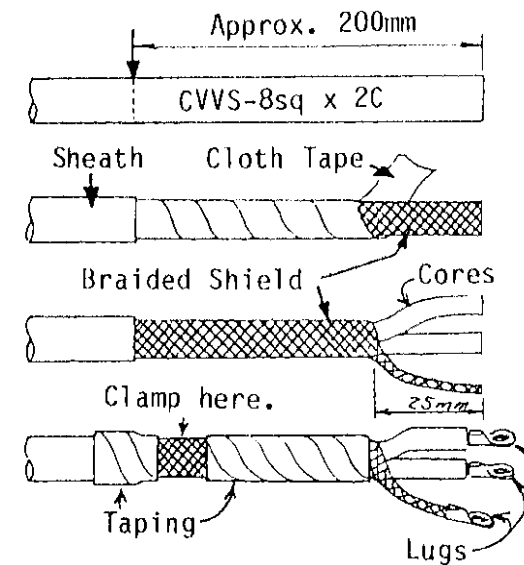

Fig.6

1. Remove vinyl sheath for 200mm with care not to cut braided shield.
2. Unwind cloth tape and cut it off together with jute at the end of outer sheath.
3. Take about 25mm of inner cores out of the braided shield.
4. Remove insulators of cores for about 10mm and fit the crimp-on lugs (8NK4).
5. Wrap the braided shield with vinyl tape, leaving a space for the clamp to make good electrical contact.

2) Expose the braided shield of the multicore cable at the point shown below.

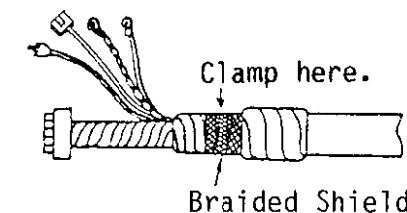

Fig.7 Multicore Cable (Display Unit side)

- 3) Remove the display unit cover by loosening eight fixing screws.
- 4) Remove the rear cover by loosening six fixing screws. See Fig.8.

- 5) Separate the clamp plate from the cable clamp by loosening two hex. bolts (A). Then secure the multicore cable and power cable to the cable clamp with the clamp plate so that the cable shield is completely grounded thru the cable clamp. See Fig.8.

Note: Improper grounding may cause interference to other nearby equipment.

- 6) To fix the cables of optional units, use the cable clamp by loosening two hex. bolts (B).
- 7) Connect 28P plug (DP-1), coax. plug (P201), 4P flying connector plug (1B1P41) and flying HV lead wire to 28P jack (DJ-1), coax. jack (J201), 4P jack (1B1J41) and terminal DTB-II #5 respectively as shown in Fig.8.
- 8) Ground the inner shield of the multicore cable to the display chassis as shown in Fig.8.
- 9) Connect the power cable to the terminals on the line filter; positive core to DTB-I #1 and negative core to DTB-I #2. Connect the shield of the power cable to the fixing screw for the filter. See Fig.8.

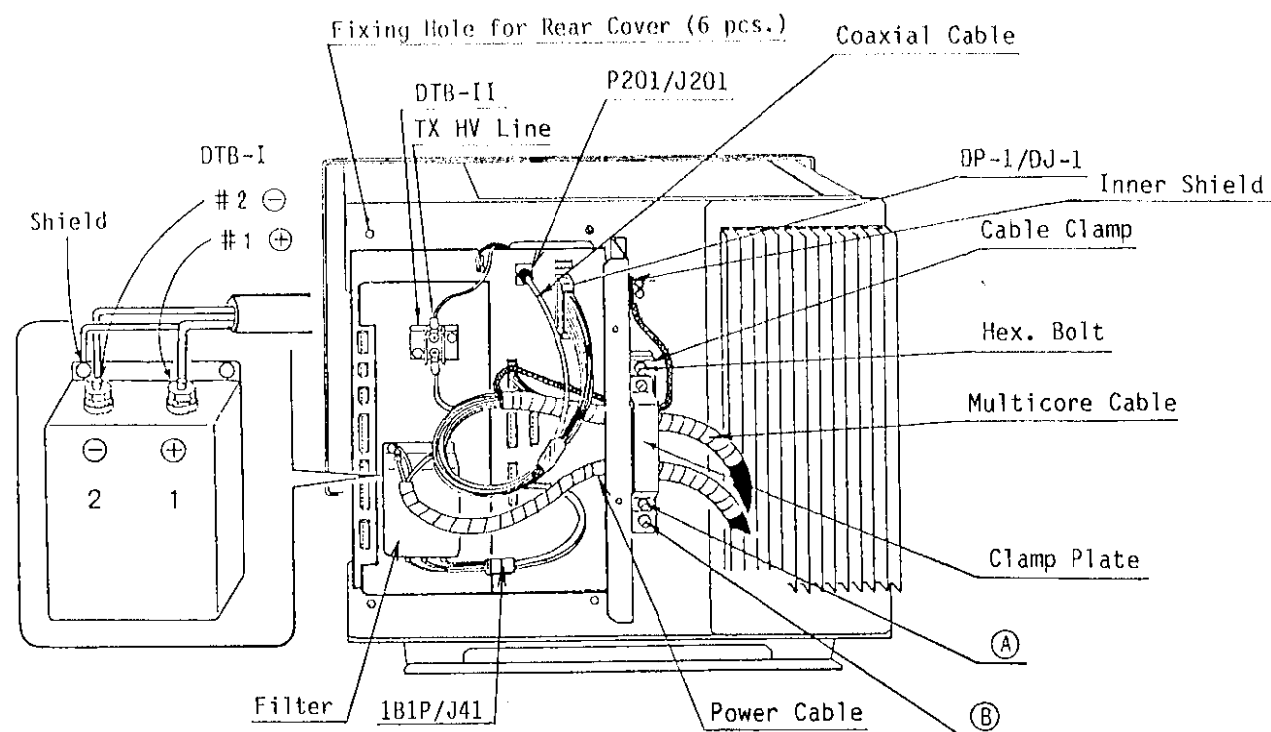

Fig.8 Rear Side View of Display Unit

Connections to Scanner Unit

The multicore cable (RW-4873) and power cable (250V-DPYCY-3.5) for de-icer (option) should be connected to the scanner unit. The procedure for connecting the cables to the scanner unit as follows.

NOTE: Care should be taken not to bring a screwdriver into contact with the magnetron to prevent demagnetization of magnetron.

Procedure:

- (1) Open the scanner housing cover of the port side by loosening six fixing bolts.
- (2) Remove the terminal board assembly from the chassis by loosening four fixing screws in order to facilitate the wirings. See Fig.9.

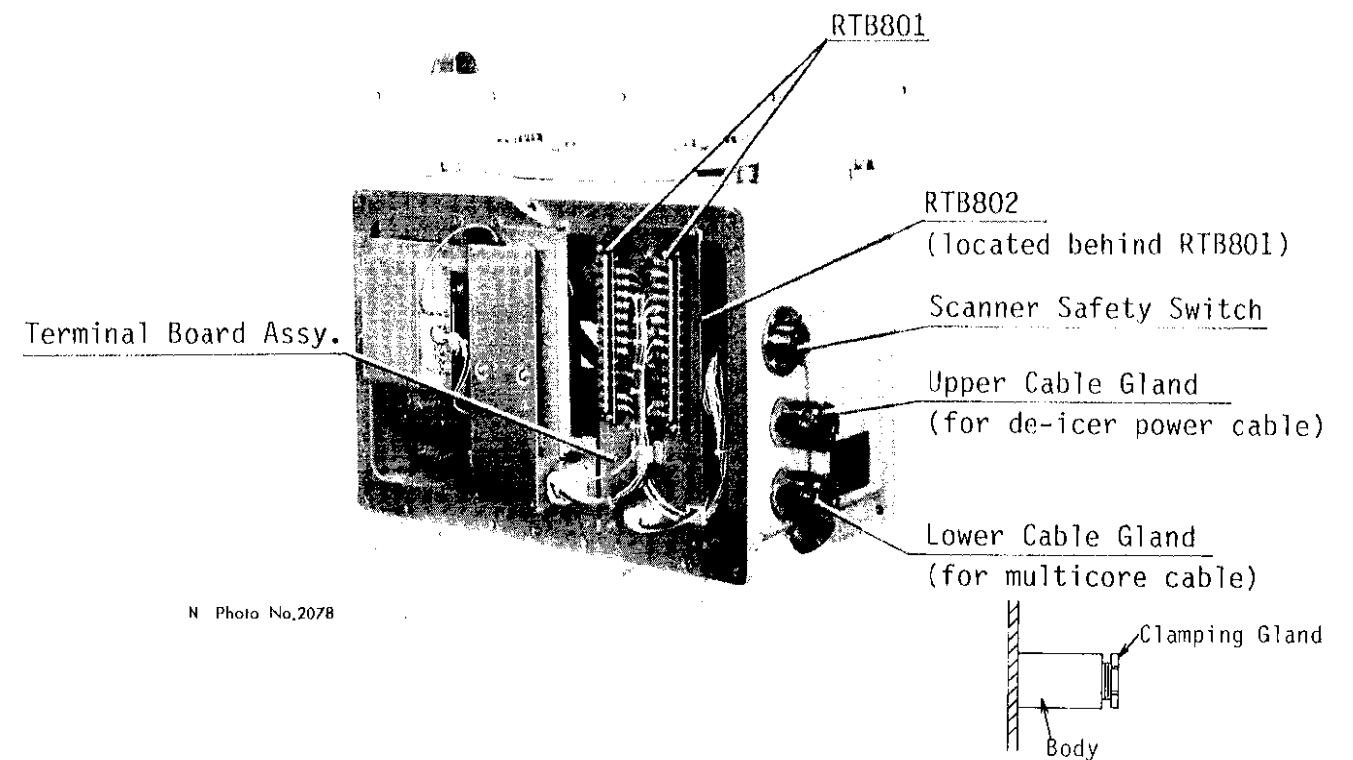
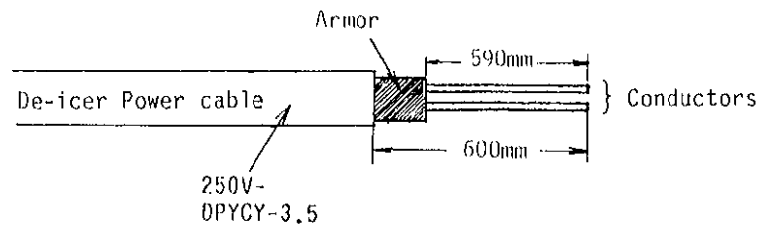

Fig.9

- (3) If de-icer is optionally installed, the power cable for de-icer should be connected to the scanner unit as follows. If not installed, skip to step 4.

1. Loosen the clamping gland of the upper cable gland and remove the rubber packing and flat washers from the body. See Fig.9.
2. Cut the cable, leaving approx. 600mm from the cable gland entry.

- Remove the vinyl sheath for approx. 600mm and the armor for approx. 590mm with care not to damage the cable cores.



**Fig.10**

- Slide the clamping gland, washers and rubber packing over the cable, and fold back the armor by 5mm, then put it between washer and cable gland body as below.

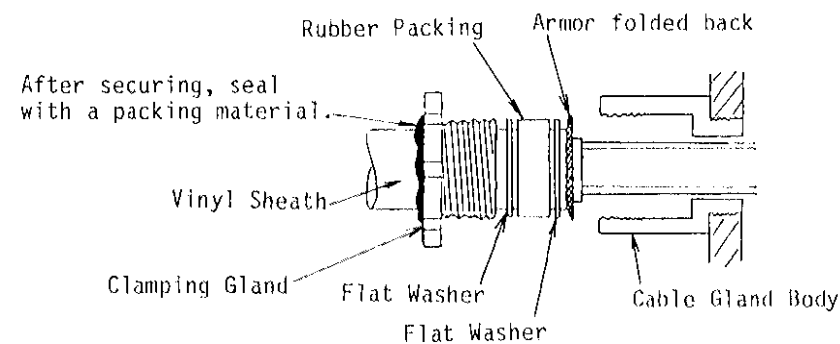

**Fig.11**

- Cut the conductors to the appropriate lengths, taking into consideration the distance to RTB802.

NOTE: The conductors should be connected to RTB802 located behind RTB801 (Fig.9).

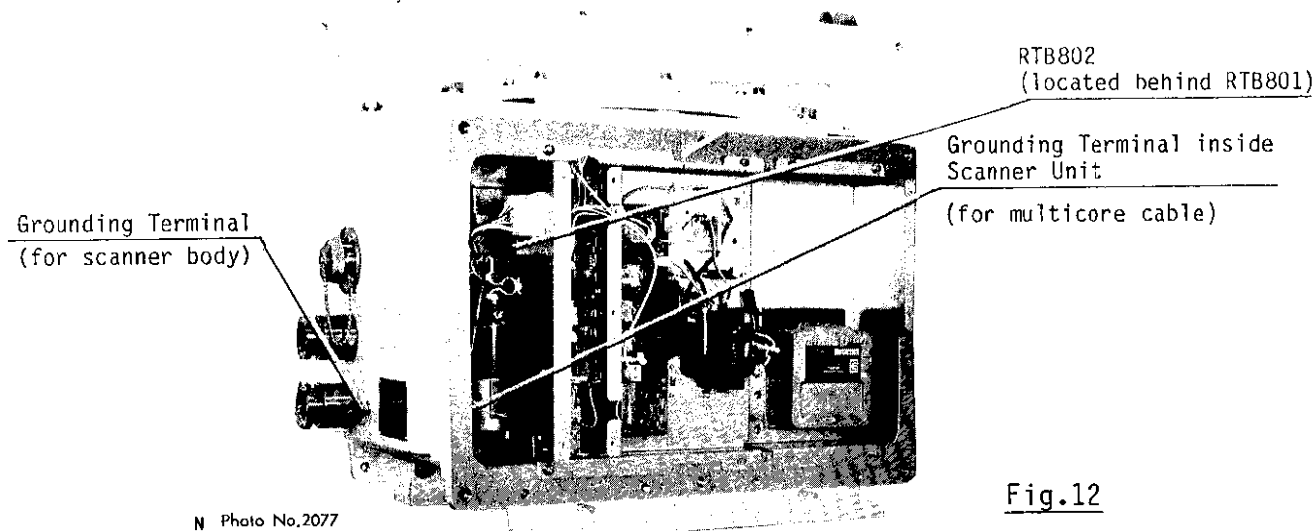

**Fig.12**

Photo No.2077

- Remove approx. 6mm of the vinyl insulation from the end of each wire, then fix crimp-on lugs on each wire by using a crimping tool. Make sure each connection is secure both electrically and mechanically.

- Secure the clamping gland to the body, then seal with a packing material. See Fig.11.

- Connect the conductors to RTB802, referring to the interconnection diagram on page AP1-21.

- Loosen the clamping gland of the lower cable gland (Fig.9) and take the rubber packing and flat washers out of the body.

- Remove the vinyl sheath of the multicore cable for approx. 600mm with care not to damage the outer shield, and take the outer layer wires and inner shield out of the outer shield as shown in Fig.13.

- Take the inner layer wires and coaxial cable out of the inner shield and mark the inner layer wires properly for identification. Then wrap the vinyl tape for insulation as shown below.

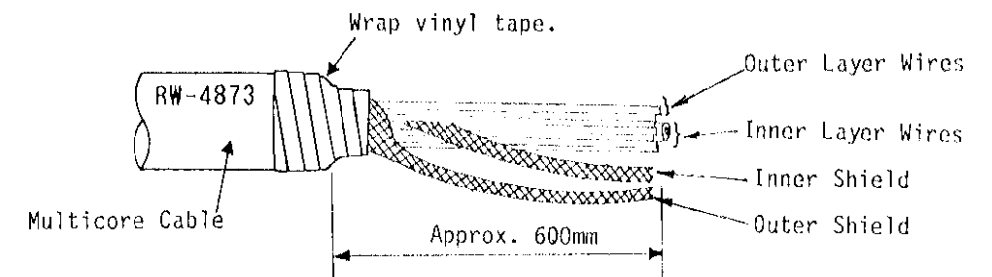

**Fig.13**

- Slide the clamping gland, washers and rubber packing over the cable. Note that the outer/inner shields are grounded with the washer as below.

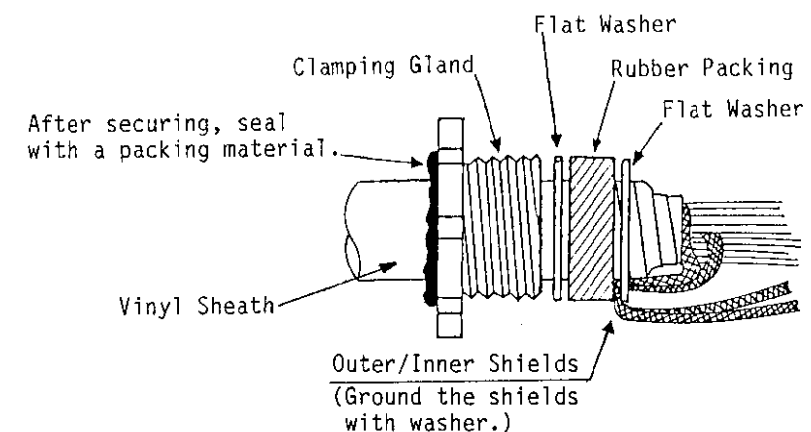

**Fig.14**

- (8) Cut each lead wire to the proper length, taking into consideration the distance to their respective terminals on RTB801 (Fig.9).
- (9) Peel off the vinyl sheath of the coaxial cable (2C-2V) for approx. 75mm and take out the inner core. Then remove approx. 24mm of insulator from the end of the inner core and fold back the conductor as below, then put crimp-on lug on the conductor. Cut the shield leaving approx. 45mm and put a crimp-on lug on the shield. Put the cloth tape over the shield and core. Be careful not to nick the inner conductor when stripping off the insulation, since it is fragile.

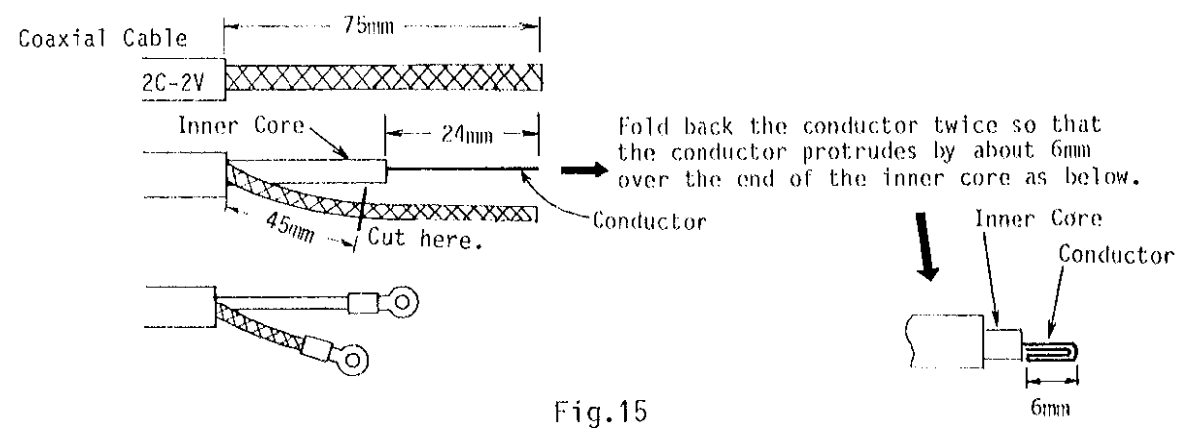

- (10) Remove approx. 6mm of the vinyl insulation from the end of each wire, and fix crimp-on lugs on each wire and outer/inner shields by using a crimping tool. Make sure each connection is secure both mechanically and electrically.
- (11) Secure the clamping gland to the body, then seal with a packing material. See Fig.14.
- (12) Connect each lead wire and outer/inner shields to RTB801 and the grounding terminal inside the scanner unit (Fig.12) respectively, referring to the interconnection diagram on page AP1-21.

NOTE: Do not forget to ground the scanner body with the grounding wire (RW-4747) supplied.

- (13) Put the terminal board assembly back in position.
- (14) Close the scanner housing covers, making sure that the packing surface of the scanner cover is properly greased and is free of dirt.

Connection to Rectifier Unit (Option)

When the ship's mains is 100/110/115/220VAC, a rectifier unit is required. (RU-1746B-2) For connection to this unit, refer to the schematic diagram on page AP1-13 and the interconnection diagram on page AP1-21.

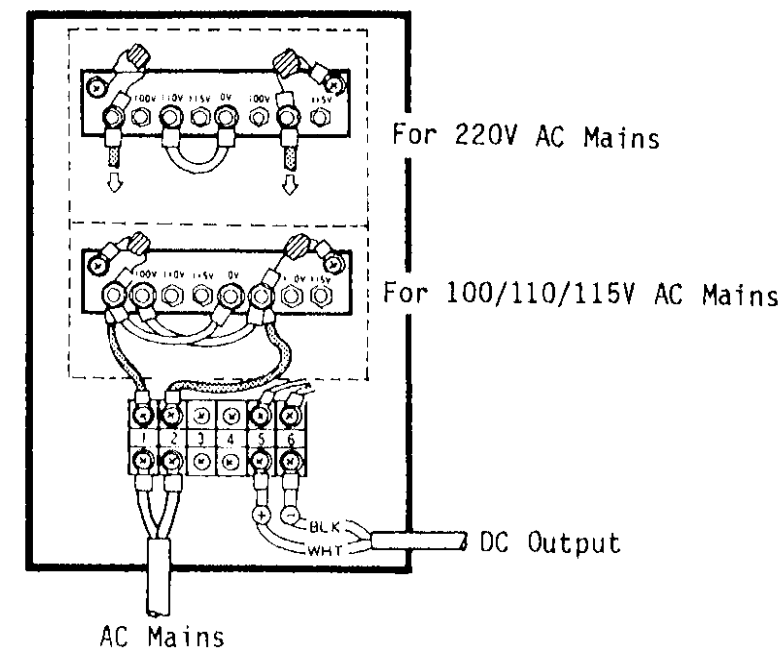

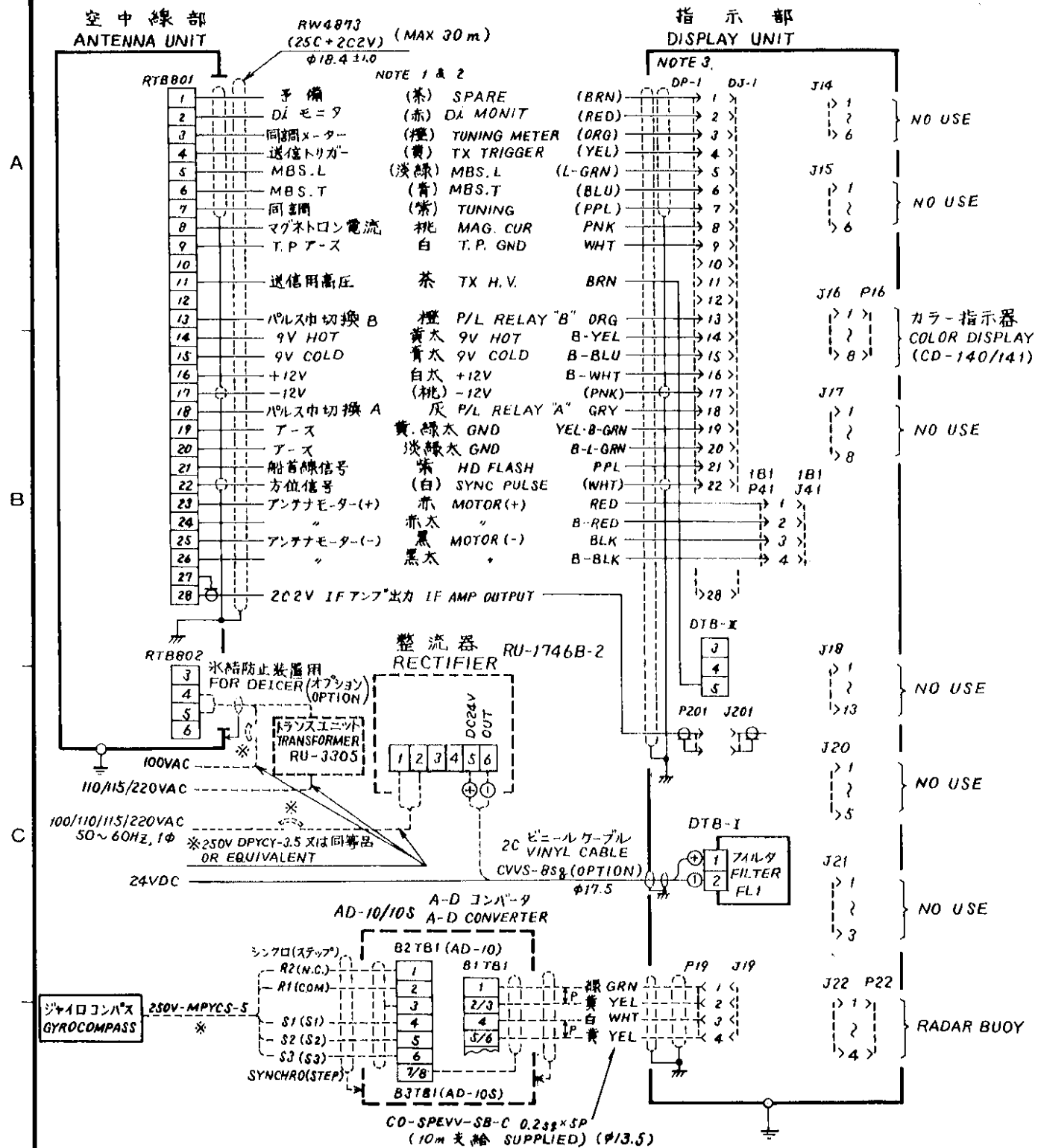

NOTE 1. カラーコードで( )は内側シールド内の線を示す。 WIRE COLOR CODE ( ): INSIDE WIRES, B-: BIG WIRES, L-: LIGHT COLOR.  
 2. シールドは両ユニット側で完全にアースすること。 SHIELD SHOULD BE EFFECTIVELY GROUNDED AT BOTH UNIT ENDS.  
 3. コネクタープラグ取付済。 CONNECTOR PLUG FACTORY-WIRED.  
 4. \*: 造船所支給。 SHIPYARD SUPPLY.

FR-810DS	品番 ITEM	品名 NAME	材質 MATERIAL	数量 Q'TY	図番 DWG. NO.	摘要 REMARKS
承認 APPROVED	FEB. 6 '86	三角法 THIRD ANGLE PROJECTION	名称 TITLE	相互結線図 INTERCONNECTION DIAGRAM		
検図 CHECKED	FEB. 6 '86	尺度 SCALE				
製図 DRAWN	FEB. 4 '86	重量 WEIGHT	kg	図番 DWG. NO.	C3291-002-C	

1.7 Preoperation Checks and Adjustment

After completion of all wiring and interconnections, check carefully that there is no wrong nor loose connection on the terminal boards. Check that the connectors and circuit boards are firmly connected to the jacks and plugs. Then, apply power and check radar functions item by item according to the following procedure.

- 1) Turn the POWER switch to "ON" and confirm that the input voltage at the terminals #1 (pos) and #2 (neg) of DTB-I on the filter is 20.4 to 31.2VDC
- 2) In about 3 minutes after switching on the radar, the indication of the "ST-BY" is presented on the screen to indicate the radar is ready to transmit.
- 3) Turn the SCANNER switch to ON and press the TX touchpad.
- 4) Check the function of controls and touchpad keys by operating them one by one.

The following adjustments should be made at installation.

1. Magnetron Heater Voltage
2. Tuning & Tuning Indicator Sensitivity
3. Transmission Timing
4. Main Bang Suppression (MBS)
5. Heading Alignment

Magnetron Heater Voltage

If the length of multicore cable is different from standard one (15m), the Magnetron Heater Voltage should be adjusted as follows:

Procedure:

- 1) Operate the radar in standby, 0.25 n.m. range, scanner rotation suspended and minimum CRT brilliance.
- 2) Connect the multimeter, set to the 10VDC range, between P801 #12(+) and #11(-). See Fig.17.
- 3) Adjust the position of the sliding contact of R812 for the meter reading of 7.3V to 7.9VDC.

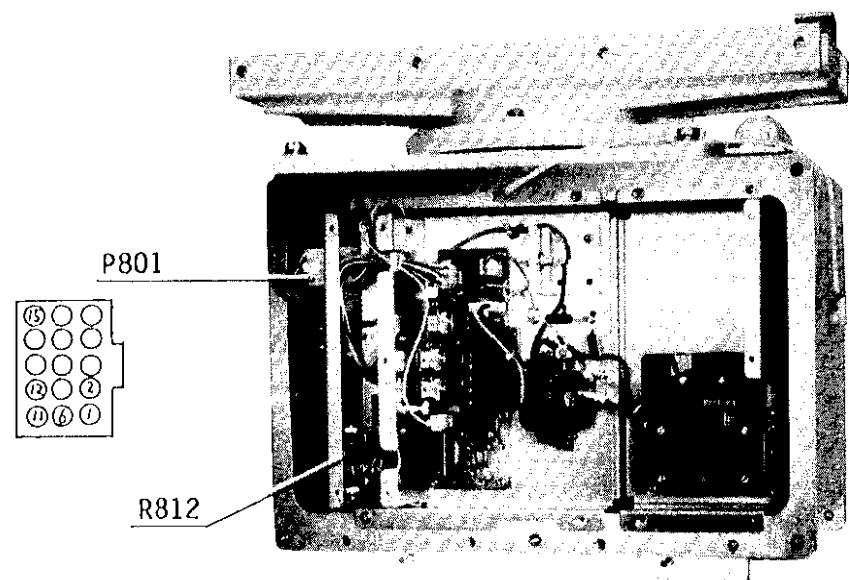

N Photo No.2079

Fig.17 Starboard View of Scanner Unit

Tuning & Tuning Indicator Sensitivity

This adjustment is already made at factory. But if the best tuning condition is not obtained with the TUNE control set at its mid-travel, execute the following procedure.

Procedure:

- 1) Transmit the radar on the maximum range with the TUNE control set at its mid-travel.
- 2) Turn VR7 on the CONTROL PANEL board (03P5553) fully CW and turn it CCW little by little until maximum number of tuning markers light up.
- 3) Adjust VR1 on the CPU board (03P5550) so that four tuning markers light up with the fifth mark blinking. Refer to Fig.20 for the locations of VR7 on the CONTROL PANEL board and VR1 on the CPU board.

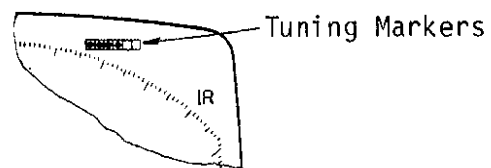

Fig.18

Transmission Timing

Transmission timing differs with respect to the length of the multicore cable between the display and the scanner units. Perform this adjustment at installation without fail, otherwise the following symptoms will appear. See Fig.19.

- \* Straight quay or breakwater appears bent inward or outward near the center spot on 0.25 n.m. range.
- \* Range error is found on short range.
- \* Wide ring appears at the screen center.

The adjustment is made with VR1 on the INTERFACE board (03P5551) in order to reject the above symptoms while observing a proper target echo on the screen. See Fig.20.

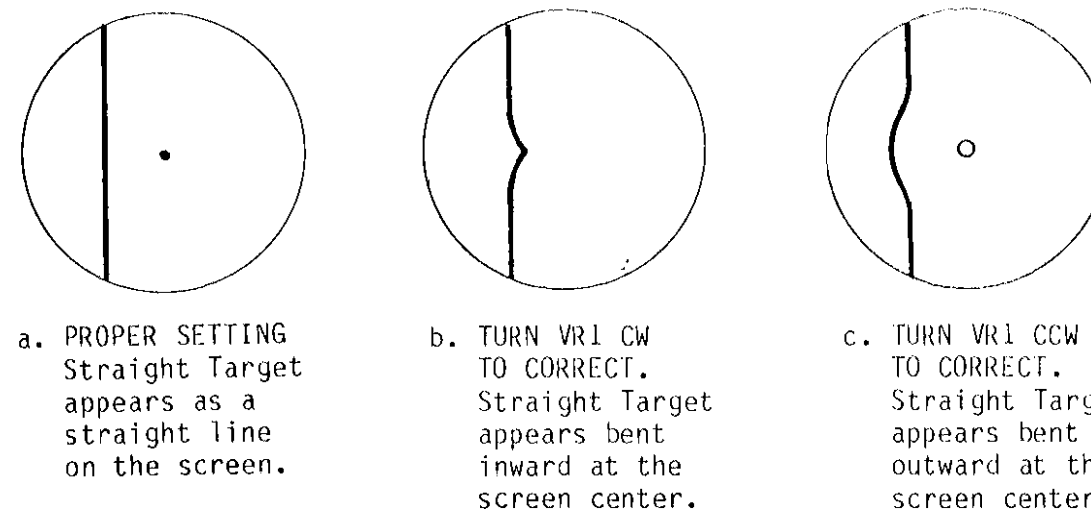

- a. PROPER SETTING  
Straight Target appears as a straight line on the screen.
- b. TURN VR1 CW TO CORRECT.  
Straight Target appears bent inward at the screen center.
- c. TURN VR1 CCW TO CORRECT.  
Straight Target appears bent outward at the screen center.

Fig.19



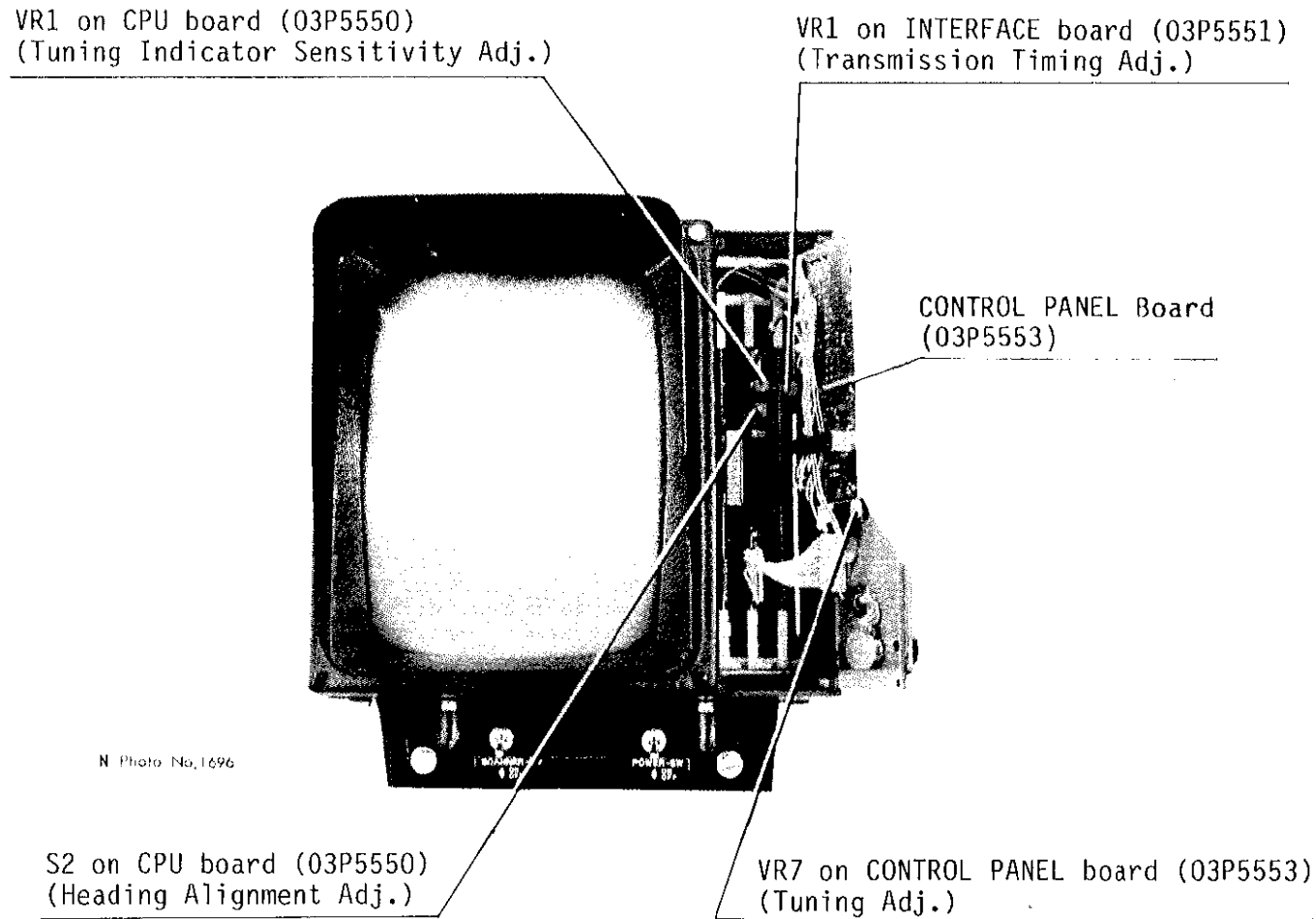

Fig.20

N Photo No.1696

Main Bang Suppression (MBS)

This adjustment is already made at factory. But if the main bang appears on the screen, perform the following procedure after Transmission Timing adjustment is done.

Procedure:

- 1) Transmit the radar on 0.25 n.m. range and adjust the GAIN and STC controls for the best picture definition.
- 2) Confirm that Transmission Timing is adjusted correctly.
- 3) Turn VR103 (MBS Level pot.) and VR104 (MBS Timing pot.) on the GSC board (03P6571) fully CW.
- 4) Turn VR104 CCW little by little until the main bang disappears.
- 5) Turn VR103 CCW little by little until the main bang ring becomes faintly visible on the screen.
- 6) Turn VR104 CCW little by little until the main bang ring disappears.

NOTE: Too high a setting of MBS (VR103 & VR104) will cause the target echo in short range to disappear.

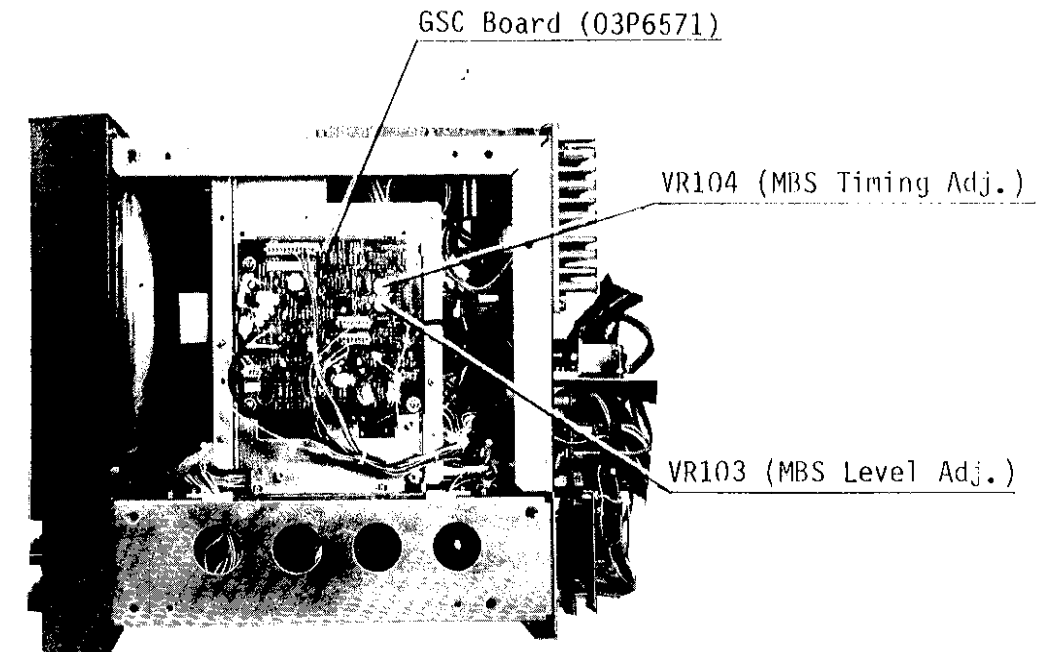

N Photo No.2049

Fig.21 Top View of Display Unit without Top Cover

Heading Alignment

Procedure:

- 1) Select the Head-up mode by pressing the MODE touchpad.
- 2) With the RANGE switch set at 3 n.m., select a proper target echo (small island, end of quay, etc.) located on or around the heading flash and near the edge of the screen.
- 3) Press the EBL-1 touchpad to present the No.1 EBL on the screen.
- 4) Rotate the No.1/No.2 VRMs & EBLs control until the EBL positions over the center of a target.

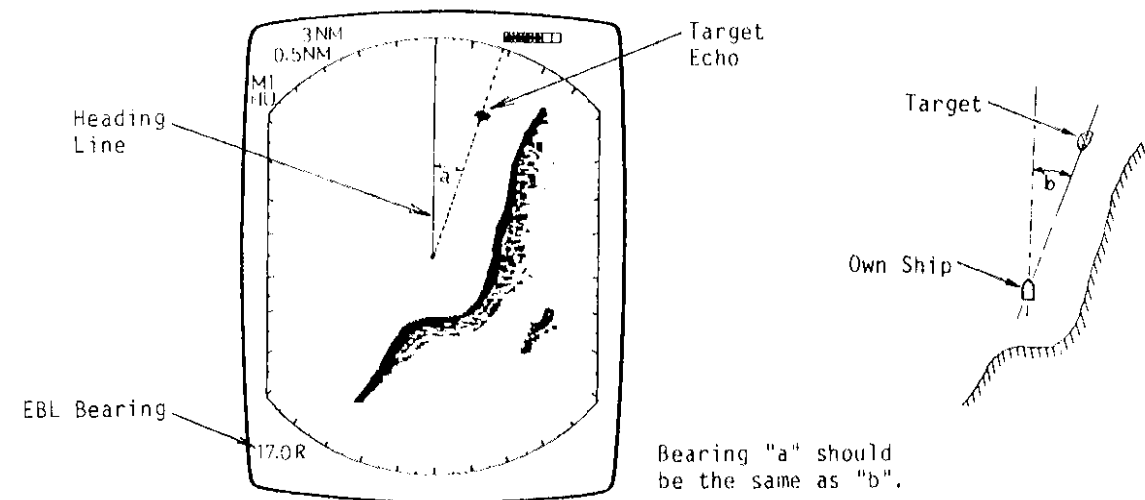

Fig.22

- 5) Read the EBL bearing at the bottom left on the screen. On the other hand, find the relative bearing of the target from the ship's heading on the navigational chart by referring to the ship's compass. The relative bearing can also be given by visually measuring the direction of the target from the ship's bow using the dumb card.
- 6) Adjust S2 on the CPU board (03P5550) so that the bearing of the target on the screen is the same as that on the navigational chart or visually measured. See Fig.20 for the location of S2.

NOTE: When the adjustment can not be completed by S2, turn the reed switch adjusting screw in the scanner unit and then readjust S2. This should be made when the scanner unit is installed with large error in direction. See Fig.23 on the next page.

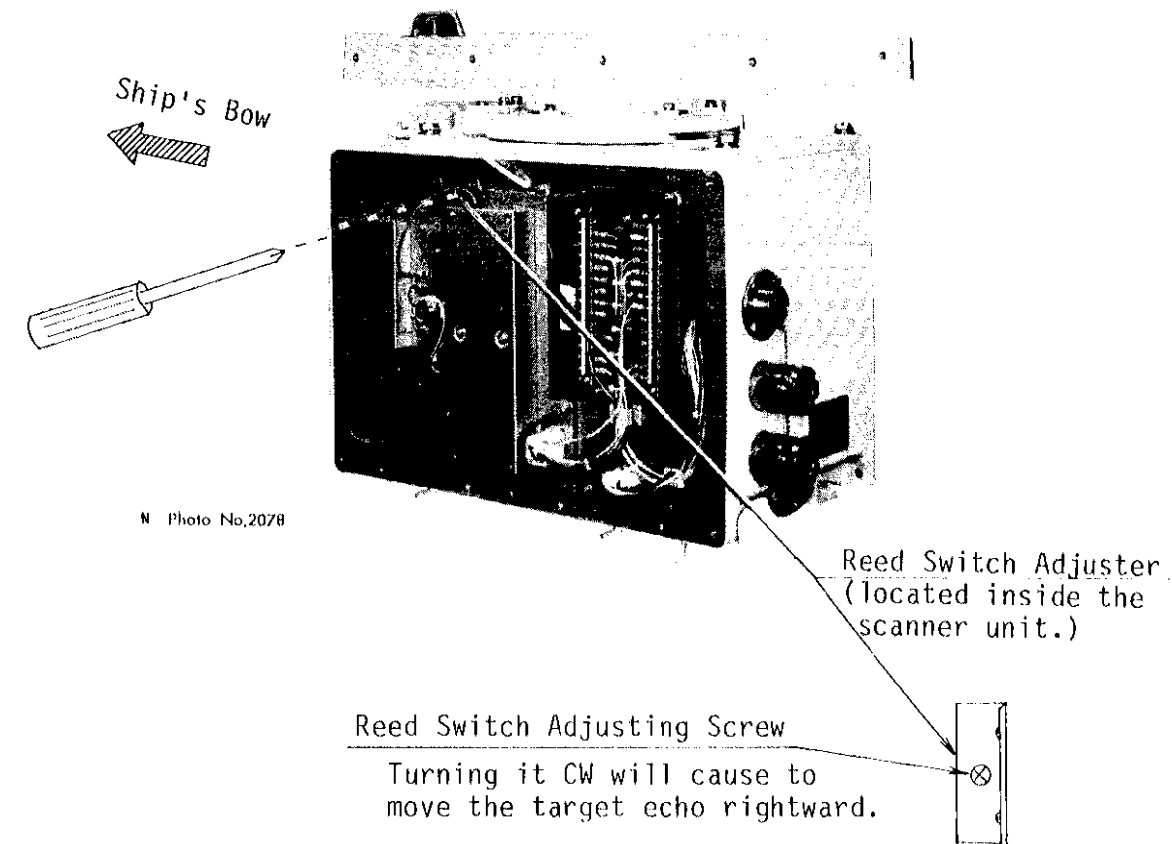
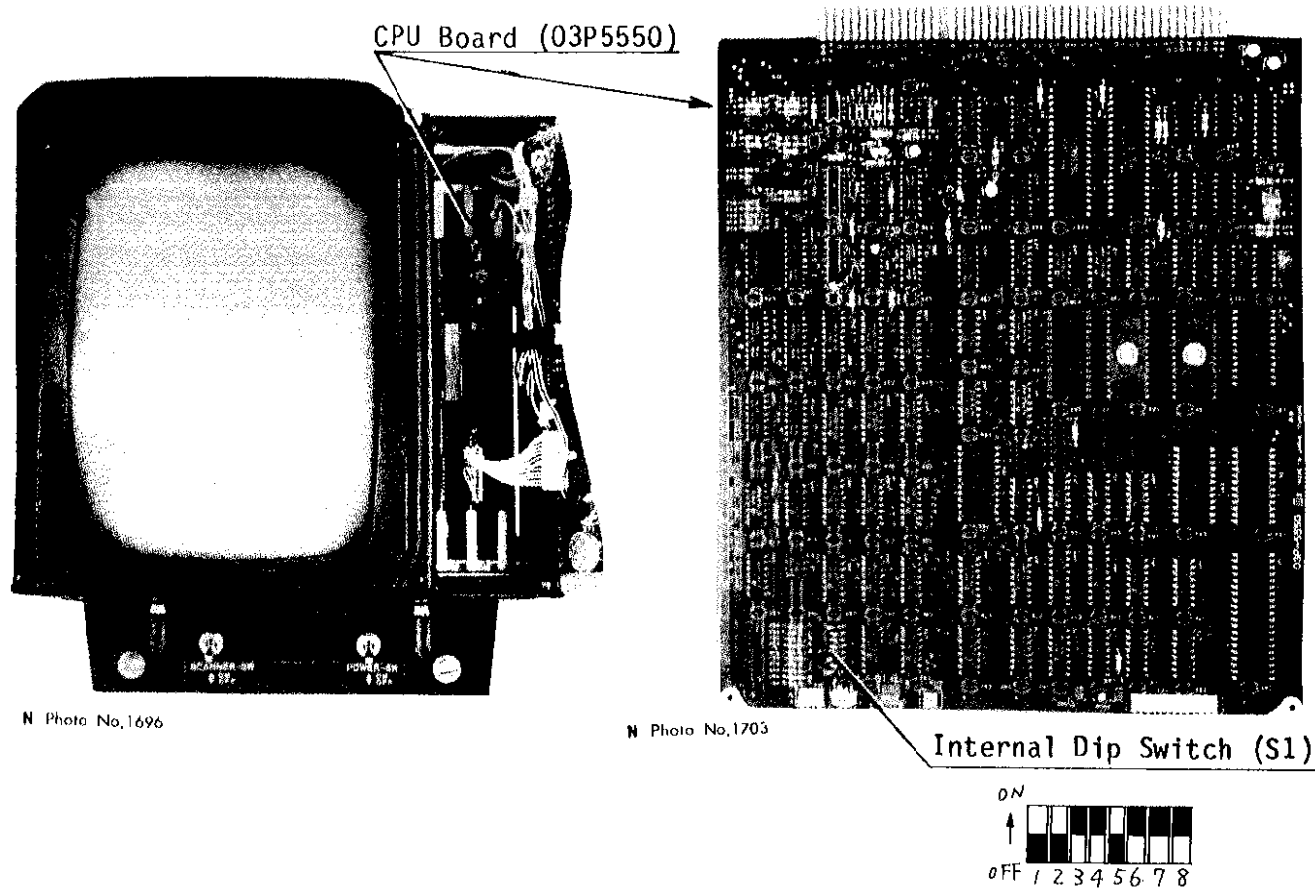

Fig.23

APPENDIX 2 SETTING OF INTERNAL DIP SWITCH

An internal dip switch (S1) is located on the CPU board (03P5550) as shown below. Note that #1, #2 and #7 of S1 are factory-use only.



N Photo No.1696

N Photo No.1703

Switch #3

"ON" : No.1 VRM is calibrated in nautical miles(NM).--- Factory-setting  
 "OFF": No.1 VRM is calibrated in kilometers(KM).

Switch #4

"ON" : No.2 VRM is calibrated in nautical miles(NM).--- Factory-setting  
 "OFF": No.2 VRM is calibrated in kilometers(KM).

Switch #5

With this switch set to "OFF", the radar is put in standby condition irrespective of the TX touchpad setting when the SCANNER switch is turned to "OFF". -----Factory setting

Switch #6

"ON" : Range ring interval is calibrated in nautical miles(NM).  
 ----- Factory-setting  
 "OFF": The range ring with 0.1Km and 0.2Km intervals are presented for 0.25 n.m. and 0.5 n.m. ranges respectively.

Range	Range Ring Interval
0.25 n.m.	0.1 Km
0.5 n.m.	0.2 Km

Switch #8

"ON" : Guard zone of the alarm is selected between 0 and 72 n.m.  
 ----- Factory-setting  
 "OFF": Guard zone setting is limited between 3 and 6 n.m.  
 When the radar is changed from TX to ST-BY, then to TX again in the middle ranges, the shorter pulselength is always selected.